

Centrometal

HEATING TECHNIQUE

Centrometal d.o.o. - Glavna 12, 40306 Macinec, Croatia, tel: +385 40 372 600, fax: +385 40 372 611

ENG

TECHNICAL INSTRUCTIONS

Installation, use and maintenance
of stainless steel water heater



TB 120 - 850

Picture 1. - TB - Basic parts

- 1 - Hot water connection
- 2 - Recirculation
- 3 - Place for temp. sensor
- 4 - Cold water connection
- 5 - Thermal insulation
- 6 - Tube heat exchanger
- 7 - Opening for cleaning (TB 120-150)
- 8 - Water draining connection
- 9 - Base of the heater
- 10 - Boiler water connection-inlet
- 11 - Boiler water connection-outlet
- 12 - Thermometer
- 13 - Opening for cleaning (TB-200-850)

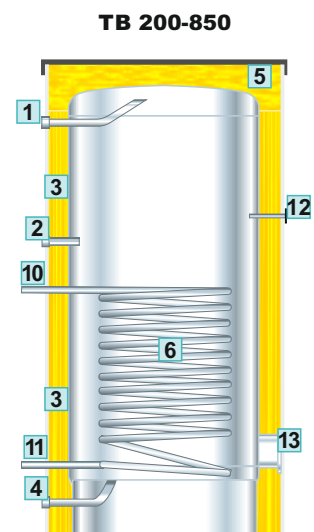
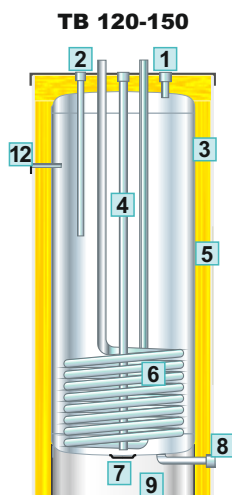

TECHNICAL DATA

TB		120	150	200	300	600	850
Volumen	(l)	121	150	200	294	545	860
Rated thermal output ⁽¹⁾ 80°C	(kW)	16,6	21	33,1	52,6	82,9	124
	(l/h)	408	515	814	1297	2045	3067
70°C	(kW)	13,3	17	26,7	39,5	63,0	94,5
	(l/h)	330	417	658	975	1554	2331
60°C	(kW)	8,3	10,5	16,5	24,5	39,0	58,5
	(l/h)	204	257	406	604	962	1443
Boiler's water flow	(m ³ /h)	1,5	1,5	1,5	5,0	5,0	5,0
Heat exch. heating surface	(m ²)	0,42	0,53	0,84	1,3	2,1	3,15
Volume of heating water	(l)	1,9	2,4	2,8	7,2	11,6	17,5
Mass	(kg)	30	41	46	63	129	157
External diameter ØA	(mm)	640	640	640	640	810	960
Diameter without insulation	(mm)	480	480	480	480	650	800
Height (B)	(mm)	970	1125	1450	1900	1995	1940
Heater water inlet / outlet	(R")	3/4"	3/4"	3/4"	1"	1"	1"
Cold / hot water	(R")	3/4"	3/4"	3/4"	3/4"	5/4"	5/4"
Recirculation	(R")	1/2"	1/2"	1/2"	3/4"	3/4"	3/4"
Water draining	(R")	3/4"	3/4"	3/4"	3/4"	5/4"	5/4"
Maximum working pressure	(bar/MPa)	6/0,6	6/0,6	6/0,6	6/0,6	6/0,6	6/0,6
Water heater body material		EN 1.4571 (X6CrNiMoTi17-12-2)					
Water heater heat exchanger mat.		EN 1.4404 (X2CrNiMo17-12-2)					
ErP class		C	C	C	C	C	C

*1 Setting temperature of the boiler hot water to 80, 70, 60 °C; DHW 10/45 °C

Picture 2. Basic dimensions of the stainless steel water heater TB

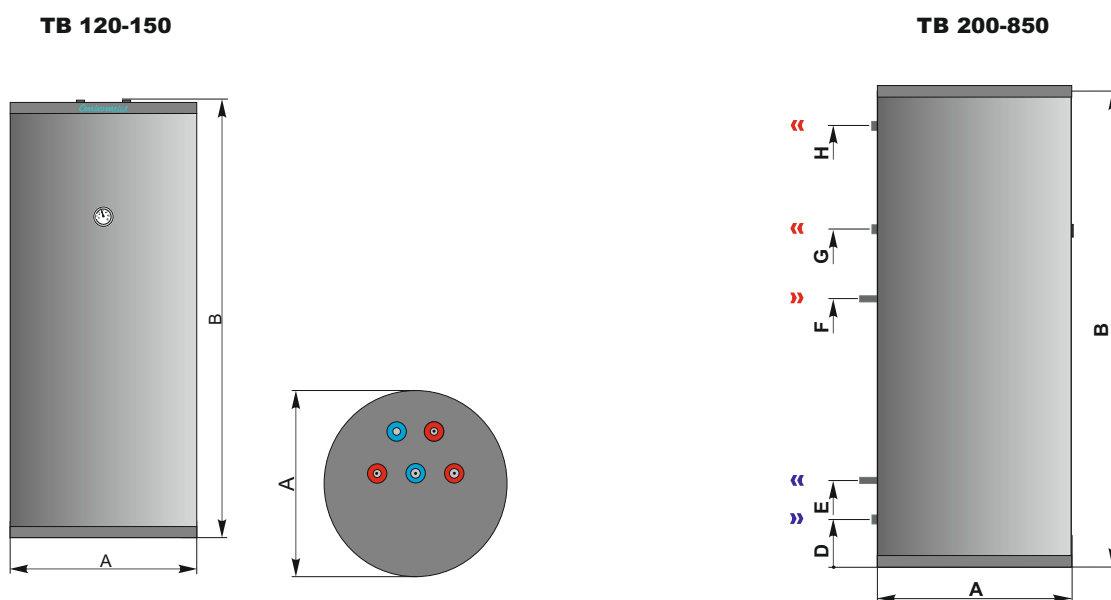

	TB 120	TB 150	TB 200	TB 300	TB 600	TB 850
Height D (mm)	92	92	92	92	100	72
Height E (mm)	-	-	300	300	390	325
Height F (mm)	-	-	810	950	1100	1075
Height G (mm)	-	-	920	1060	1200	1375
Height H (mm)	-	-	1150	1650	1710	1640

HEAT EXCHANGER PRESSURE DROP FOR TB 120 - 850

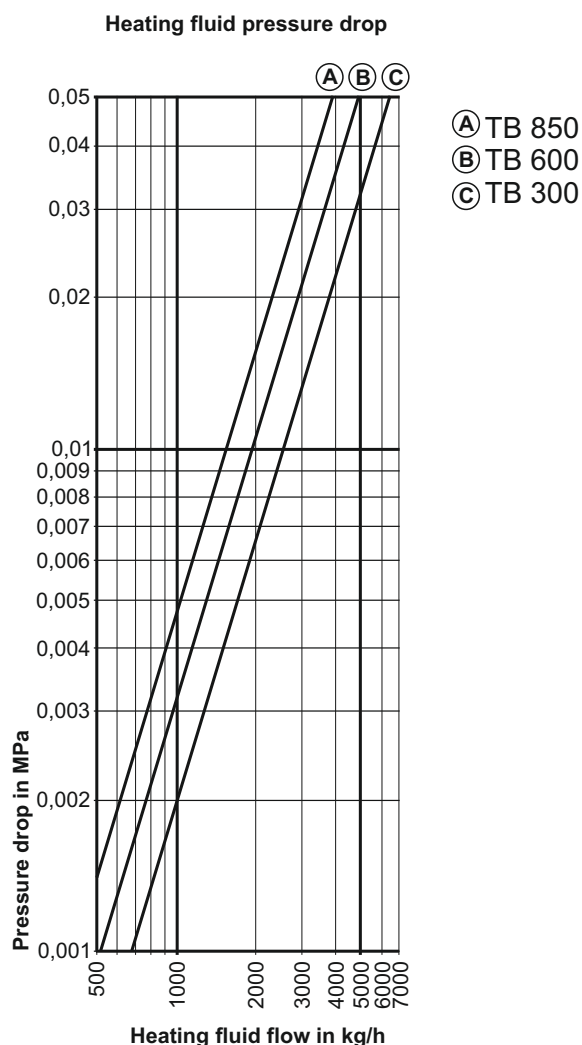
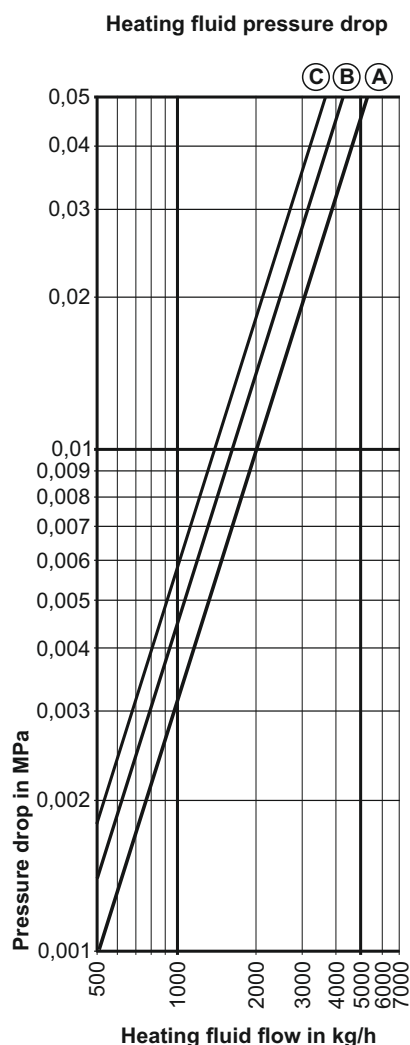

1.0. INTRODUCTION

The stainless steel water heater **TB** is manufactured with most modern welding technology, made from materials of great quality which assures high efficiency when using and guarantees the product quality. Boilers **TB** are made from 120-150 with connections on the top side and boilers **TB** 200-850 with connections on the back side. The water heater is manufactured from stainless steel and was tested under the probe pressure of 1,2 Mpa (12 bar), with inbuilt thermometer. Supplied with 80 mm thick thermal insulation coated with hard plastic on the outside. This instructions have to be carefully studied, to learn about correct assembling, handling, use and maintainance. This is necessary in order to enable your combined hot water boiler to operate according to its purpose and produce heat for your home for many years.

2.0. PURPOSE

Water heaters **TB** are engineered for heating and accumulating of domestic hot water with the connection to the boiler circuit or to another heat source being part of some technological process. Often they are connected to solar systems for additional accumulation with solar water heaters STB. Water heaters are made of stainless steel, which guarantees a high hygienic level. Wide application of modern technologies and the quality of the material as well as double checked technical solutions, allows grade of heat exchange and minimal loss of temperature. Produced in compliance with ISO 9001

3.0. MOUNTING

The water heater is factory insulated, with thermometer and hermetic fittings on heat exchanger connections, and it is delivered on the pallet. If it cannot pass through a door, insulation can be taken off and put on in the room afterwards. TB is intended for mounting on the flat surface in the room for such application (boiler room, energy station, ...).

4.0. CONNECTION TO THE WATER SUPPLY AND HEATING SYSTEM

The water heater connection to a water supply system must be done with accordance with valid technical standards by a qualified person (Scheme 1). The cold water inlet is the lowest connection on the heater, marked with a blue rosette, and the hot water outlet is the highest connection, marked with a red rosette.

On the cold water inlet is **obligatory to install** following elements:

- domestic hot water expansion vessel
- water heater drain cock (obligatory install it with the T-piece)
- the safety valve (certified to open at 6 bar)
- check valve
- pressure reduction valve to decrease a cold water inlet pressure to the 4 bar (if the pressure is higher).

The safety valve must be regularly controlled, limescale must be removed because it can block the flow to the safety valve. The safety valve outlet must be installed in barometric pressure environment that never freezes. In order to have a longer operation life it is recommended to install a water softener, especially if the heater is connected to a municipal water supply system (hard water and water with chlorine), and if galvanized water tubes are used, which can harm stainless steel materials. Recirculation connection is placed between the top and bottom heat exchanger, marked with red rosette on all models except TB 850, where it is located between the upper and lower connection of the upper tubular exchanger.

A thermostatic 3-way valve and recirculation pump installation must be done upon one of two ways, depending on the purpose or position of taps.

Scheme 2. shows the recirculation pump installation in the system with two or more thermostatic 3-way valves. Different temperature can be set for certain group of taps that are placed after the thermostatic 3-way valve. Smaller valve can be selected depending on the number of taps.

Scheme 3. shows the thermostatic 3-way valve installation for all taps, right on the heater hot water outlet. If even one of the shown elements in the scheme is missing, the recirculation will not work properly.

The schemes 2. And 3. do not show required elements for connection to the municipal water supply system, but those elements must be installed as it is shown in Scheme 1.

Shema 1. - Connection stainless steel water heater to the water supply and heating system

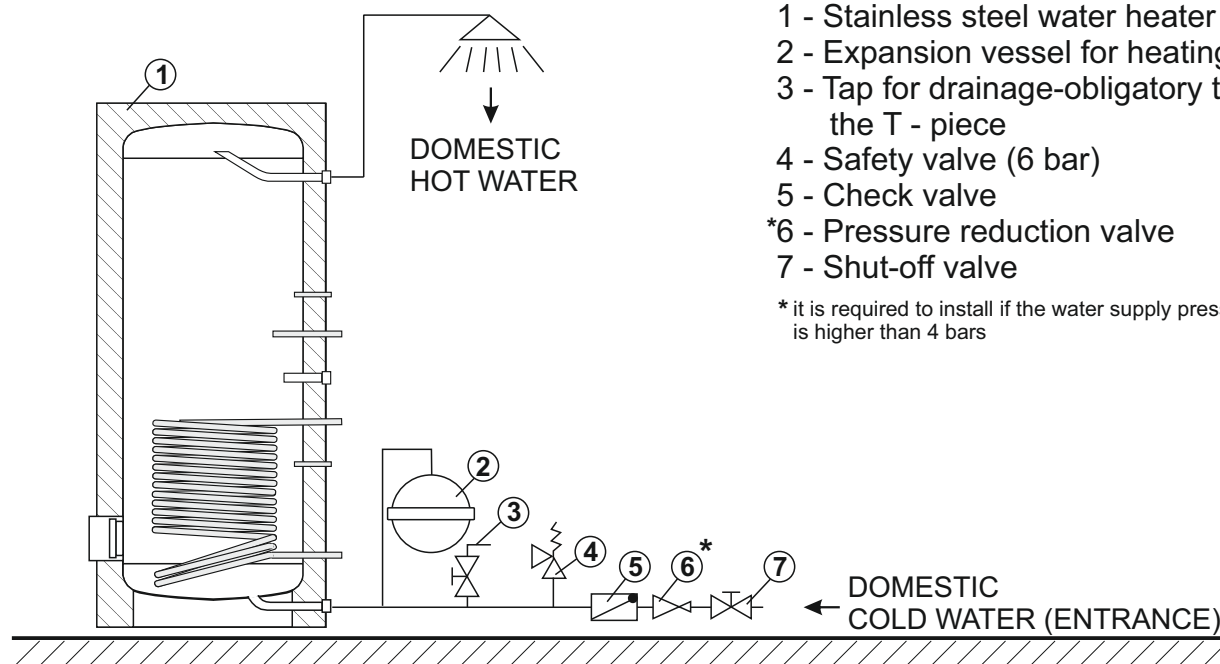

Scheme 2. Recirculation pump installation to the system with two or more thermostatic 3-way mixing valves

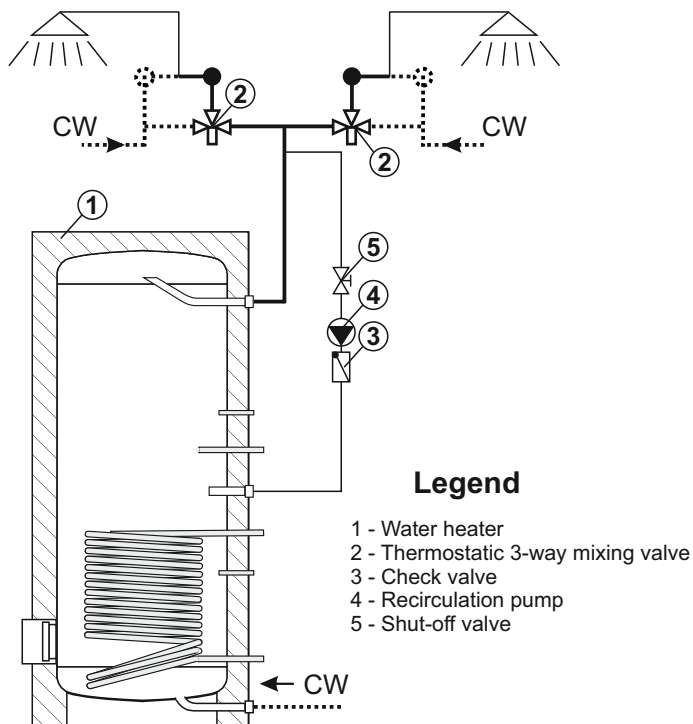

Scheme 3. Thermostatic 3-way mixing valve installation for all taps, right on the heater hot water outlet, with recirculation pump

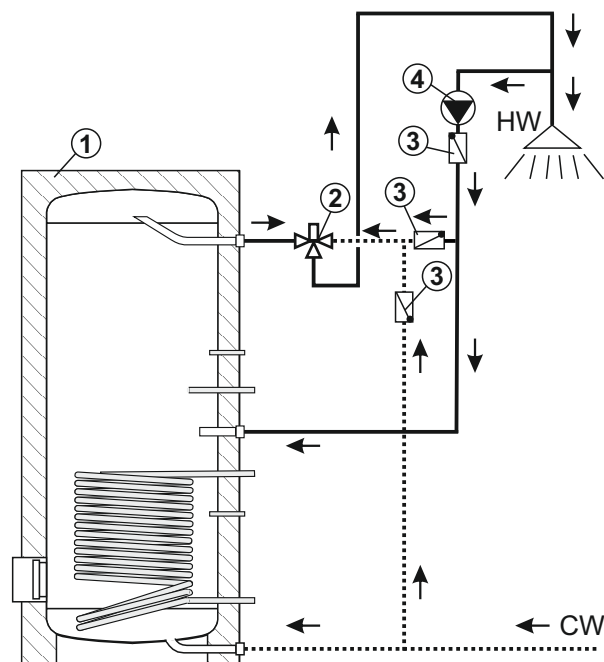

On scheme 4, is shown an example ways of connecting the boiler to system for heating domestic hot water. Connections on the heat exchangers are marked with rosettes (red ones on the inlets and blue ones on the outlets). Connection must be done with ermeto fittings that are factory mounted at the heat exchanger ends. Before commissioning, air-vent must be done.

Schema 4. - example of connection

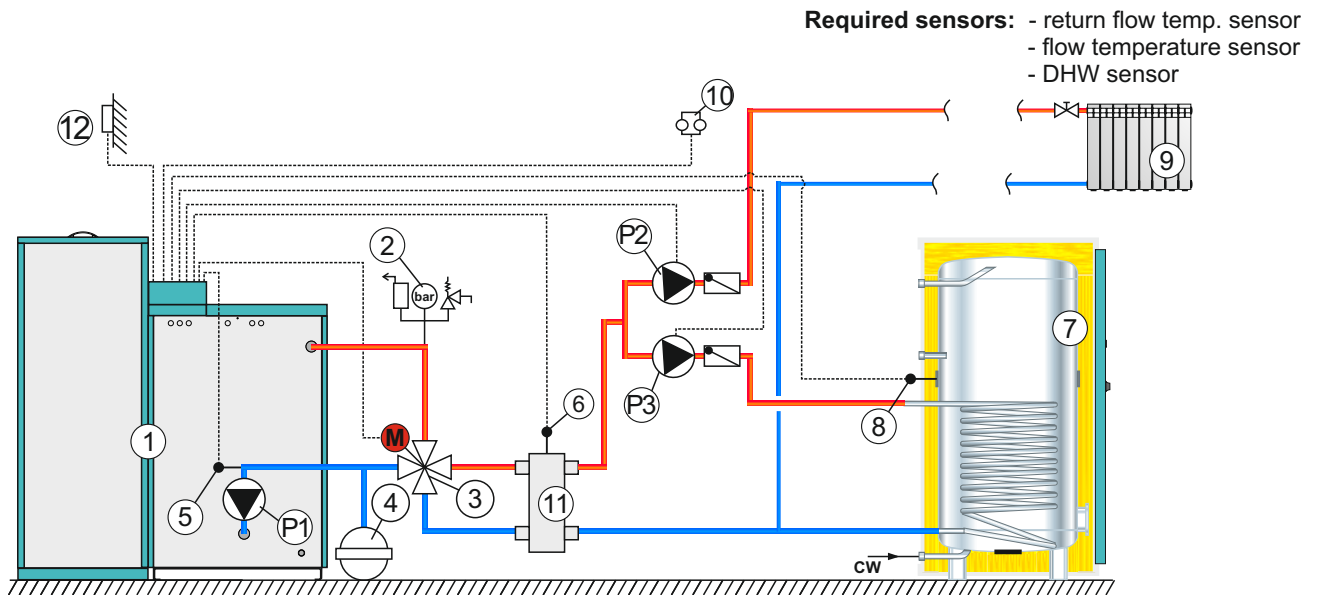

- 1 - Boiler
- 2 - Air self-venting group 2,5 bar
- 3 - 4-putni miješajući ventil s motornim pogonom
- 4 - Closed type expansion vessel
- 5 - Return flow sensor
- 6 - Flow sensor

- 7 - Boiler TB
- 8 - DHW sensor
- 9 - Heating circuit
- 10 - Room thermostat
- 11 - Hydraulic crossover
- 12 - Outdoor sensor

Picture 3. Insert the sensor on DHW tank of boiler control unit for TB

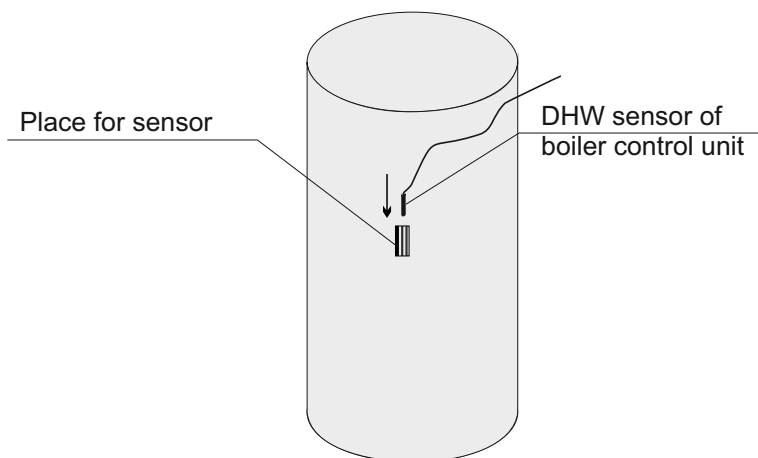

5.0. HEATER MAINTENANCE TB

It must not be used by children or disabled persons (either physically or mentally), as well as by person without knowledge or experience, unless they are under control or trained by s person responsible for their safety. Children should be supervised to ensure that they do not play with the appliance. At necessary to check and clean it from the scale and sediment (depend of water quality). Before the cleaning it is obligatory to disconnect the stainless steel water heater from the power supply and discharge it (through the tap for drainage on the cold water installation, picture 1).

After that is necessary tako off the cover of cleaning opening which is bottom of the stainless steel water heater TB 120-150 or front side at TB 200-850 (Picture 1).

After cleaning cover must be returned to opening for cleaning (Picture 1).

6.0. ENERGY LABELS

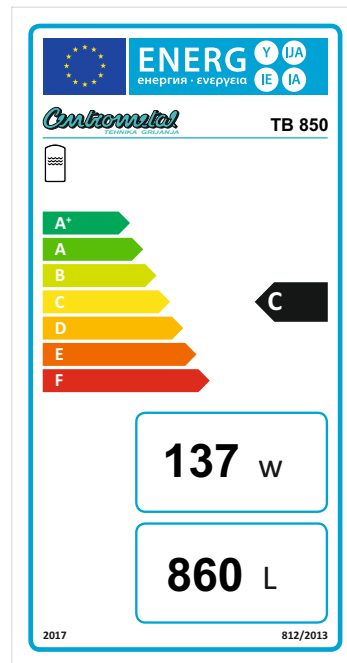
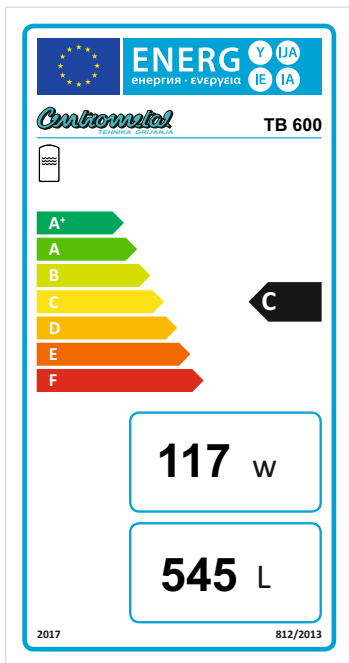
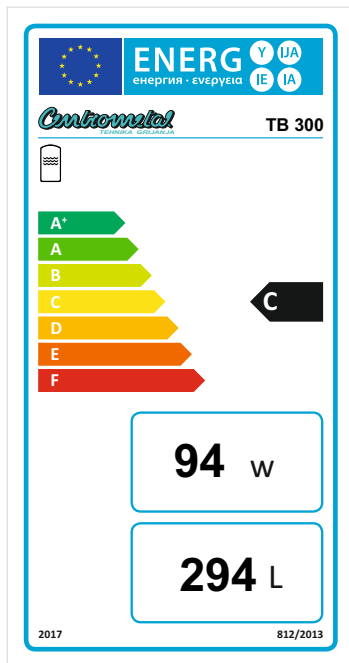
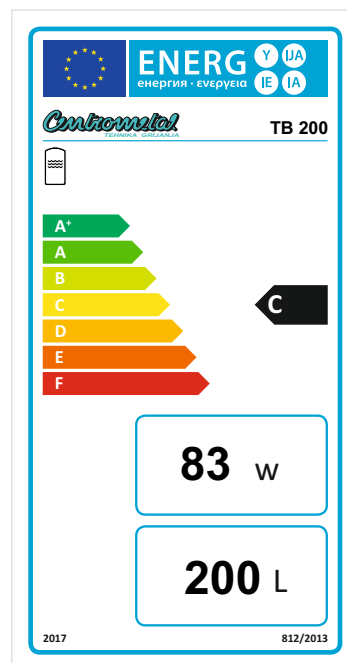
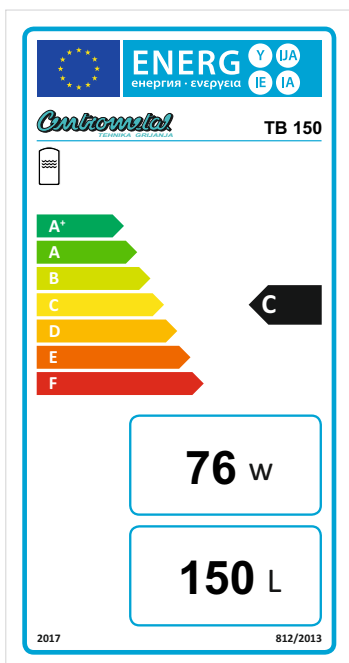
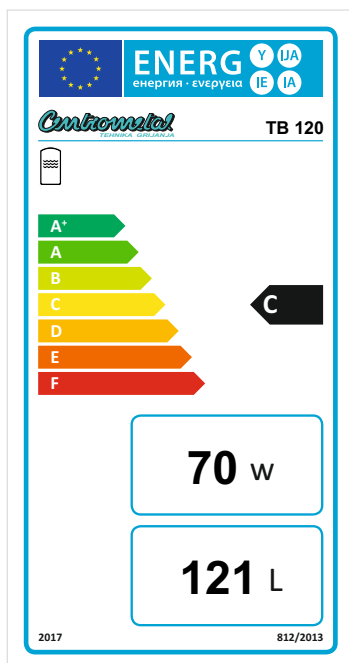



IZJAVA O SUKLADNOSTI
EC DECLARATION OF CONFORMITY
CONFORMITY DECLARATION

Proizvođač
 Manufacturer: **Centrometal d.o.o.**
 Naziv i adresa
 Name and address: **HR-40306 Macinec, Glavna 12, Croatia**

punom odgovornošću izjavljuje, da
We declare under our sole responsibility that

Proizvod /
 Product designation: **Inox spremnik potrošne tople vode / Stainless steel domestic hot water tank**
 Tip / model
 Type / model: **TB 120, TB 150, TB 200, TB 300, TB 600, TB 850**

odgovara zahtjevima sljedećih propisa
is in conformity with the provisions of the following regulations

1. **Direktiva 2009/125/EC**
Directive 2009/125/EC
2. **Direktiva 2010/30/EC**
Directive 2010/30/EC

i također zadovoljava zahtjeve sljedećih uredbama
and also complies with the following regulations

Directive 2009/125/EC	Commission Regulation (EU) No 814/2013
Directive 2010/30/EC	Commission Regulation (EU) No 812/2013

Godina izdavanja CE oznake
 Year of affixing of CE marking **2010.**

Mjesto i vrijeme izdavanja:
 Place and date of issue

Macinec, 25. 06. 2019.

Ime, prezime i potpis ovlaštene osobe
 Name, surname and signature of authorized person

Davor Zidarić

Centrometal
 ③ 40306 MACINEC, Glavna 12
 Centrala 040/372-600, Fax: 372-611



Centrometal d.o.o. shall not be responsible for possible incorrect data caused by printing errors or error made in transcription and all figures and diagrams are for explanatory purposes only and relevant adjustment have to be made at the spot. In any case, it reserves the right to modify its products as deemed to be required and useful without any prior notification.

Centrometal d.o.o. Glavna 12, 40306 Macinec, Croatia

central tel: 040 372 600, fax: 040 372 611
service tel: +385 40 372 622, fax: +385 40 372 621

www.centrometal.hr
e-mail: servis@centrometal.hr

Centrometal
HEATING TECHNIQUE
