

Centrometal

HEATING TECHNIQUE

Centrometal d.o.o. - Glavna 12, 40306 Macinec, Croatia, tel: +385 40 372 600, fax: +385 40 372 611

ENG

TECHNICAL MANUAL



for installation, use and maintenance
of heat pump

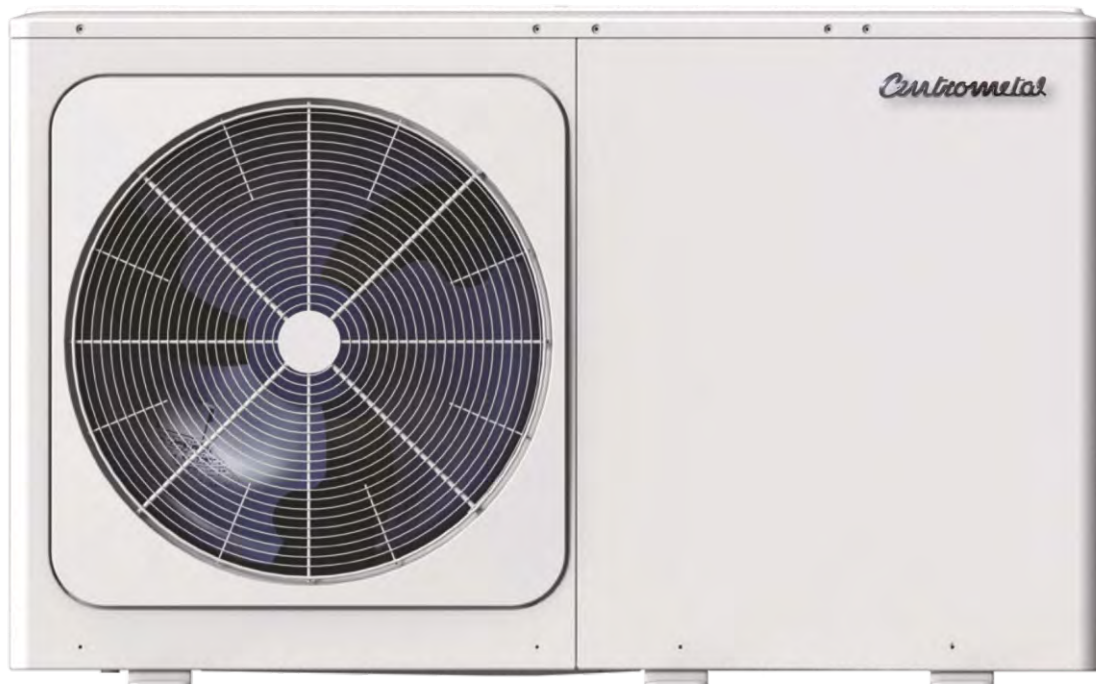

THE FIRST START-UP MUST BE DONE BY AUTHORIZED PERSON,
OTHERWISE PRODUCT WARRANTY IS NOT VALID.

R290 Mono Heat pumps

CONTENTS

Part 1	General Information	3
Part 2	Engineering Data	19

Part 1

General Information

1 R290 Mono system	4
2 Product lineup	6
3 Nomenclature	7
4 System design and unit selection	8

1 R290 Mono system

1.1 System

Centrometal R290 Mono is an integrated air to water heat pump system which is one-step solution for space heating, space cooling and domestic hot water. The outdoor heat pump system extracts heat from the outdoor air and transfers this heat through refrigerant piping to the plate heat exchanger in the hydronic system. The heated water in the hydronic system circulates to low temperature heat emitters (floor heating loops or low temperature radiators) to provide space heating, and to the domestic hot water tank to provide domestic hot water. The 4-way valve in the outdoor unit can reverse the refrigerant cycle so that the hydronic system can provide chilled water for cooling by fan coil units.

The heating capacity of heat pumps decreases with ambient temperature dropping. Centrometal R290 Mono are equipped with a backup electric heater to provide additional heating capacity for use during extremely cold weather when the heat pump capacity is insufficient. The backup electric heater also serves as a backup in case of heat pump malfunction and for anti-freeze protection of the outside water piping in winter.

1.2 System configurations

Centrometal R290 Mono can be configured to run with the electric heater either enabled or disabled and can also be used in conjunction with an auxiliary heat source such as a boiler.

The chosen configuration affects the size of heat pump that is required. Three typical configurations are described below.

Configuration 1: Heat pump only

- The heat pump covers the required capacity and no extra heating capacity is necessary.
- Requires selection of larger capacity heat pump and implies higher initial investment.
- Ideal for new construction in projects where energy efficiency is paramount.

Configuration 2: Heat pump and backup electric heater

- Heat pump covers the required capacity until the ambient temperature drops below the point at which the heat pump is able to provide sufficient capacity. When the ambient temperature is below this equilibrium point (as shown below), the backup electric heater supplies the required additional heating capacity.
- Best balance between initial investment and running costs, results in lowest lifecycle cost.
- Ideal for new construction.

Configuration 3: Heat pump with auxiliary heat source

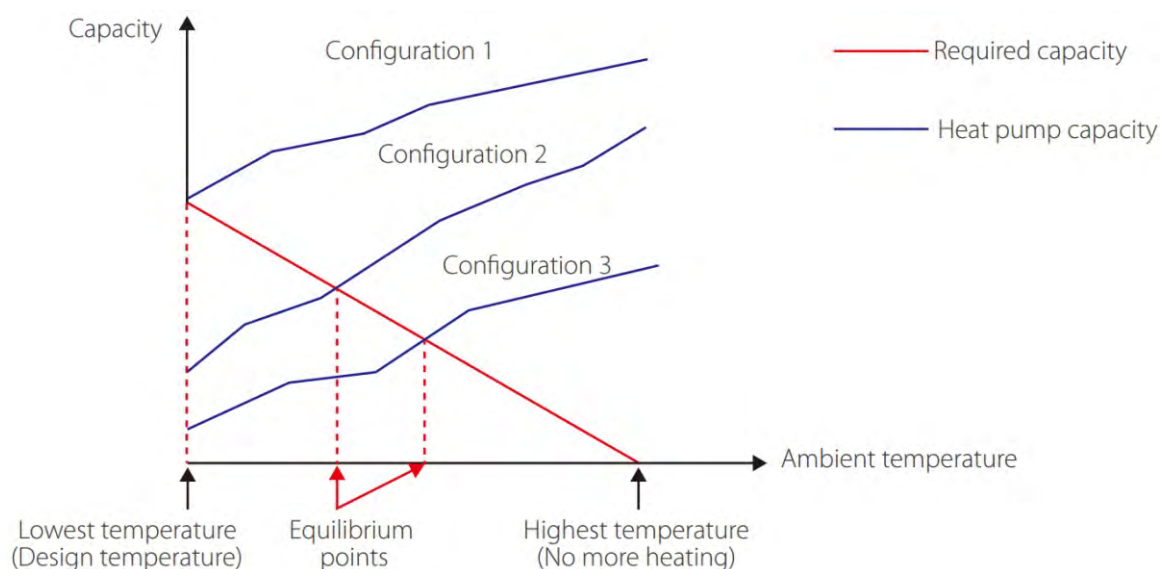

- Heat pump covers the required capacity until the ambient temperature drops below the point at which the heat pump is able to provide sufficient capacity. When the ambient temperature is below this equilibrium point (as shown below), depending on the system settings, either the auxiliary heat source supplies the required additional heating capacity or the heat pump does not run and the auxiliary heat source covers the required capacity.
- Enables selection of lower capacity heat pump.
- Ideal for refurbishments and upgrades.

Figure 1-1.1: System configurations



2 Product lineup

Table 1-1.1: Product lineup

Power supply	220-240V/1N/50Hz	
Model	MHP6R290CM	MHP10R290CM
Appearance		

Power supply	380-415V/3N/50Hz	
Model	MHP16R290P3CM	
Appearance		

3 Nomenclature

Table 1-1.2: Nomenclature

M	HP	10	R290	P3	CM
1	2	3	4	5	6

Legend		
No.	Code	Remarks
1	M	Type: Monobloc
2	HP	Product: Heat Pump
3	10	Capacity code: 6 = 6 kW; 10 = 10 kW; 16 = 16 kW
4	R290	Refrigerant type: R290
5	P3	Power supply: Omitted = 1-phase (220-240V, 50Hz); P3 = 3-phase (380-415V, 50Hz)
6	CM	Brand: Centrometal

4 System design and unit selection

4.1 Selection procedure

Step 1: Total heat load calculation

Calculate conditioned surface area
 Select the heat emitters (type, quantity, water temperature and heat load)

Step 2: System configuration

Decide whether to include AHS and set AHS's switching temperature
 Decide whether backup electric heater is enabled or disabled

Step 3: Selection of outdoor units

Determine required total heat load on outdoor units
 Set capacity safety factor
 Select power supply

Provisionally select Centrometal R290 Mono unit capacity based on nominal capacity

Correct capacity of the outdoor units for the following items:
 Outdoor air temperature / Outdoor humidity / Water outlet temperature¹ /
 Altitude / Anti-freeze fluid

Is corrected R290 Mono unit capacity \geq Required total heat load on outdoor units²

Yes

No

Centrometal R290 Mono system selection is complete

Select a larger model or enable backup electric heater operation

Notes:

1. If the required water temperatures of the heat emitters are not all the same, the Centrometal R290 Mono unit's outlet water temperature setting should be set at the highest of the heat emitter required water temperatures. If the water outlet design temperature falls between two temperatures listed in the outdoor unit's capacity table, calculate the corrected capacity by interpolation.
2. If the outdoor unit selection is to be based on total heating load and total cooling load, select Mono units which satisfy not only the total heating load requirements but also the total cooling load requirements.

4.2 R290 heat pump leaving water temperature (LWT) selection

The recommended design LWT ranges for different types of heat emitter are:

- For floor heating: 30 to 35°C;
- For fan coil units: 30 to 45°C;
- For low temperature radiators: 40 to 50°C.

4.3 Optimizing system design

To get the most comfort with the lowest energy consumption with Centrometal R290 Mono, it is important to take account of the following considerations:

- Choose heat emitters that allow the heat pump system to operate at as low a hot water temperature as possible whilst still providing sufficient heating.
- Make sure the correct weather dependency curve is selected to match the installation environment (building structure, climate) as well as ender user's demands.
- Connecting room thermostat (supplied by user) to the hydronic system helps prevent excessive space heating by stopping the outdoor unit and circulation pump when the room temperature is above the thermostat set point.

4.4 Selection of the buffer tank and DHW tank

4.4.1 Selection of the buffer tank

The heat pump must be connected to the buffer tank in order to satisfy the minimum amount of water in the system. The volume of the buffer tank must be selected according to table 1-4.1.

Table 1-4.1: Minimum buffer tank volume

Model	Buffer tank [L]
5-9 kW	≥25
16 kW	≥40
Cascade	≥40*n

n = number of heat pumps in cascade

4.4.2 Selection of the DHW tank

The heat pump can be connected to the DHW tank. The tank can be with or without a built-in electric heater. The electric heater of the DHW tank must be installed below the tank temperature sensor. The tank temperature sensor must be above the heat exchangers in the tank. For the correct operation of the DHW heating system with a heat pump, it is necessary to comply with the minimum requirements of the DHW tank given in table 1-4.2.

Table 1-4.2: Minimum requirements of the DHW tank

Model		6 kW	10 kW	16 kW
DHW tank volume [L]	Recommended	100-250	150-300	200-500
Heat exchanger area - stainless steel coil [m ²]	Minimum	1,4	1,4	1,6
Heat exchanger area - enamel coil [m ²]	Minimum	2,0	2,0	2,5

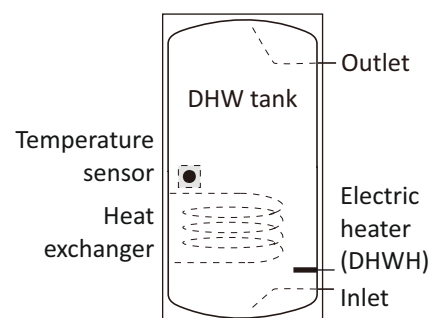

Part 2

Engineering Data

1 Specifications	20
2 Electric characteristics	23
3 Dimensions and center of gravity	24
4 Operating limits	25
5 Hydronic performance	27
6 Capacity tables	29
7 Sound levels	44

1 Specifications

R290 Arctic HT Series			MHP6R290CM	MHP10R290CM	MHP16R290P3CM
Power supply	V/Ph/Hz		220-240/1/50		380-415/3/50
Backup electric heater	Power supply	V/Ph/Hz	220-240/1/50		380-415/3/50
	Capacity	kW	3		9
Heating A7W35	Capacity	W	6200	10000	15000
	Rated input	W	1265	2128	3409
	COP		4.90	4.70	4.40
Heating A7W45	Capacity	W	6400	10000	15000
	Rated input	W	1684	2740	4478
	COP		3.80	3.65	3.35
Heating A7W55	Capacity	W	6200	9500	15000
	Rated input	W	2000	3115	5263
	COP		3.10	3.05	2.85
Heating A2W35	Capacity	W	5600	8200	12800
	Rated input	W	1436	2247	4000
	COP		3.90	3.65	3.20
Heating A2W45	Capacity	W	5800	8200	13100
	Rated input	W	1871	2780	4764
	COP		3.10	2.95	2.75
Heating A2W55	Capacity	W	5800	8400	13100
	Rated input	W	2189	3360	5347
	COP		2.65	2.50	2.45
Heating A-7W35	Capacity	W	5900	8000	12700
	Rated input	W	2000	2807	5080
	COP		2.95	2.85	2.50
Heating A-7W45	Capacity	W	5500	7600	12500
	Rated input	W	2200	3378	5556
	COP		2.50	2.25	2.25
Heating A-7W55	Capacity	W	5200	7400	12400
	Rated input	W	2419	3524	6049
	COP		2.15	2.10	2.05
Cooling A35W18	Capacity	W	6500	10000	16000
	Rated input	W	1275	2105	4103
	EER		5.10	4.75	3.90
Cooling A35W7	Capacity	W	6800	8900	14000
	Rated input	W	2194	2738	5091
	EER		3.10	3.25	2.75

R290 Arctic HT Series			MHP6R290CM	MHP10R290CM	MHP16R290P3CM
Seasonal space heating energy efficiency class	Water outlet at 35°C		A+++		
	Water outlet at 55°C		A++		
SCOP	Warmer climate	35°C	6.14	7.11	6.05
		55°C	4.55	4.79	4.62
	Average climate	35°C	4.89	5.07	4.59
		55°C	3.82	3.82	3.57
	Colder climate	35°C	4.24	4.54	4.08
		55°C	3.38	3.49	3.29
SEER	Water outlet	7°C	5.32	5.55	5.12
		18°C	6.65	8.16	6.65
Erp Sound power level		dB	58	61	69
Sound power level	Heating A7W35	dB	58	61	69
	Heating max	dB	60	63	70
	Heating Silence mode 1	dB	56	59	64
	Heating Silence mode 2	dB	53	56	60
	Cooling A35W18	dB	58	61	69
	Cooling max	dB	60	63	70
	Cooling Silence mode 1	dB	56	58	64
	Cooling Silence mode 2	dB	53	55	60
Sound pressure level (1m)	Heating A7W35	dB(A)	46	49	56
	Heating max	dB(A)	48	51	58
	Heating Silence mode 1	dB(A)	44	46	52
	Heating Silence mode 2	dB(A)	42	43	48
	Cooling A35W18	dB(A)	46	49	56
	Cooling max	dB(A)	48	51	58
	Cooling Silence mode 1	dB(A)	43	46	52
	Cooling Silence mode 2	dB(A)	40	43	48
Sound pressure level (2m)	Heating A7W35	dB(A)	42	45	52
	Heating max	dB(A)	44	47	54
	Heating Silence mode 1	dB(A)	40	42	48
	Heating Silence mode 2	dB(A)	37	40	43
	Cooling A35W18	dB(A)	42	45	52
	Cooling max	dB(A)	44	47	54
	Cooling Silence mode 1	dB(A)	40	42	48
	Cooling Silence mode 2	dB(A)	37	40	43

R290 Arctic HT Series			MHP6R290CM	MHP10R290CM	MHP16R290P3CM
Water flow range		m ³ /h	0.4 - 1.25	0.4 - 2.10	0.7 - 3.00
Compressor	Type		Twin rotary		
Outdoor fan	Motor type / Number of fans		DC fan / 1		
Air side heat exchanger			Finned tube heat exchanger		
Refrigerant			R290 700g	R290 1100g	R290 1250g
Unit dimension (W×H×D)		mm	1299×717×426	1385×865×523	1385×865×523
Packing dimension (W×H×D)		mm	1375×885×475	1465×1035×560	1465×1035×560
Net weight		kg	90	117	142
Gross weight		kg	110	139	164
Water side heat exchanger			Plate heat exchanger		
Water side connection dimension			G1"BSP	G1 1/4"BSP	
Water pump	Max. pump head	m	9		
Expansion vessel (primary circuit)	Nominal volume	L	8		
	Max. working pressure	bar	8		
Safety valve		MPa	0.3		
Flow switch		m ³ /h	0.36		0.6
Outdoor air temperature range	Cooling	°C	-5 ~ 46		
	Heating	°C	-25 ~ 35		
	DHW	°C	-25 ~ 46		
Water setting temperature range	Cooling	°C	5 ~ 25		
	Heating	°C	25 ~ 75		
	DHW	°C	20 ~ 70		
Notes: The above data test reference standard EN 14511; EN 14825; EN 50564; EN 12102; (EU) No: 811.					

2 Electrical characteristics

Heat pumps

System	Outdoor unit			Power current			Compressor		Fan	
	Power supply	Min. (V)	Max. (V)	MCA (A)	TOCA (A)	MFA (A)	MSC (A)	RLA (A)	kW	FLA (A)
MHP6R290CM	220-240/1N/50Hz	198	264	13.5	15	16	/	10	0.08	0.32
MHP10R290CM	220-240/1N/50Hz	198	264	17.5	19	20	/	13	0.17	0.80
MHP16R290P3CM	380-415/3N/50Hz	342	456	9.5	11	16	/	18	0.20	1.25

Capacity (kW)		6	10	16
Outdoor unit	Phases	1		3
	Voltage and frequency	220-240 V, 50 Hz		380-415 V, 50 Hz
	The wire cross-sectional area (mm ²)	3 x 2,5		5 x 2,5
	Fuse (A)	16/1ph	20/1ph	16/3ph

Backup heater

System	Outdoor unit			Power current		
	Power supply	Min. (V)	Max. (V)	MCA (A)	TOCA (A)	MFA (A)
3kW 1-PH	220-240/1N/50Hz	198	264	13.5	13.5	20
9kW 3-PH	380-415/3N/50Hz	342	456	13.5	13.5	20

Capacity (kW)		3	9
Backup electric heater	Phases	1	3
	Voltage nad frequency	220-240 V, 50 Hz	380-415 V, 50 Hz
	The wire cros-sectional area (mm ²)	3 x 2,5	5 x 2,5
	Fuse (A)	20/1ph	20/3ph

Notes:

Name	Description	Explanation
Min. & Max.	Minimum & Maximum running voltage (V)	Required voltage range for system operation
MCA	Min. Circuit Amps. (A)	To determine the minimum wire diameter
TOCA	Total Over-curent Amps. (A)	The maximum current for protecting system
MFA	Max. Fuse Amps. (A)	To determine air-break switch / circuit breaker / fuse
MSC	Max. Starting Amps. (A)	The starting current of the inverter compressor is very small and can be ignored
RLA	Rated Load Amps. (A)	The input Amps of compressor where MAX. Hz can operate for nominal cooling or heating test condition
kW	Rated Motor Output	/
FLA	Full Load Amps. (A)	The current measured by the motor at rated voltage and rated speed (usually the highest speed of Motor) under rated load

For models with backup heater, the backup heater does not share wiring with the unit, so it needs to be connected seperately.

3 Dimensions and center of gravity

6 kW

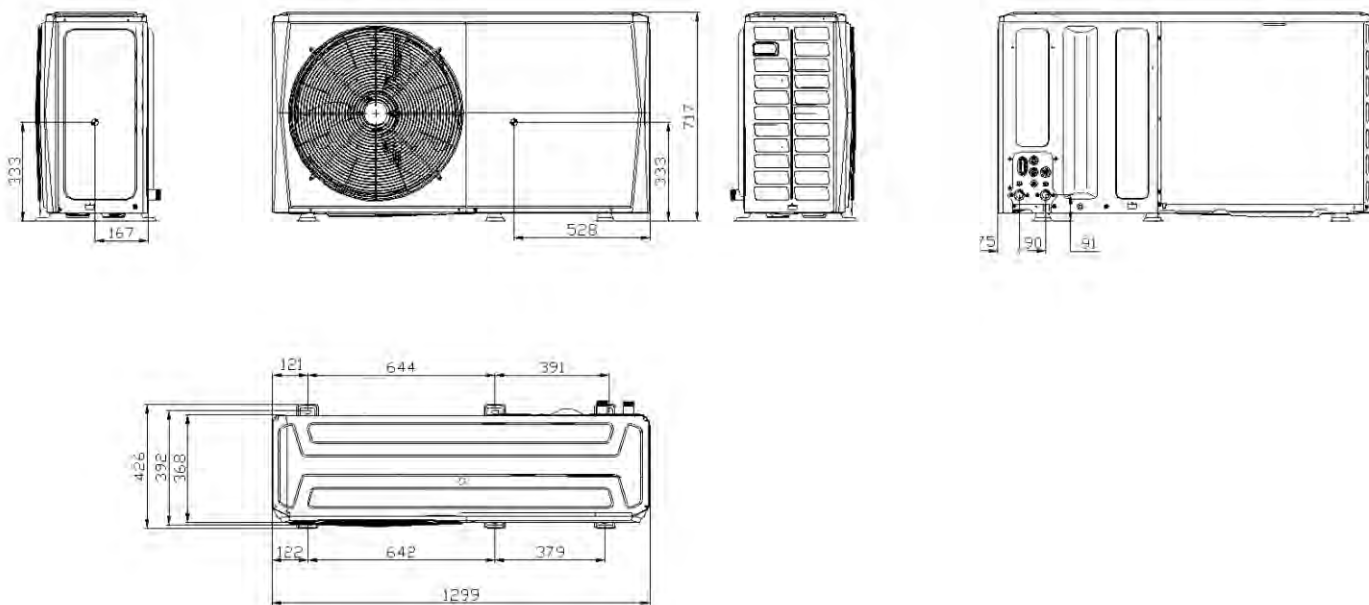

unit: mm

10 and 16 kW

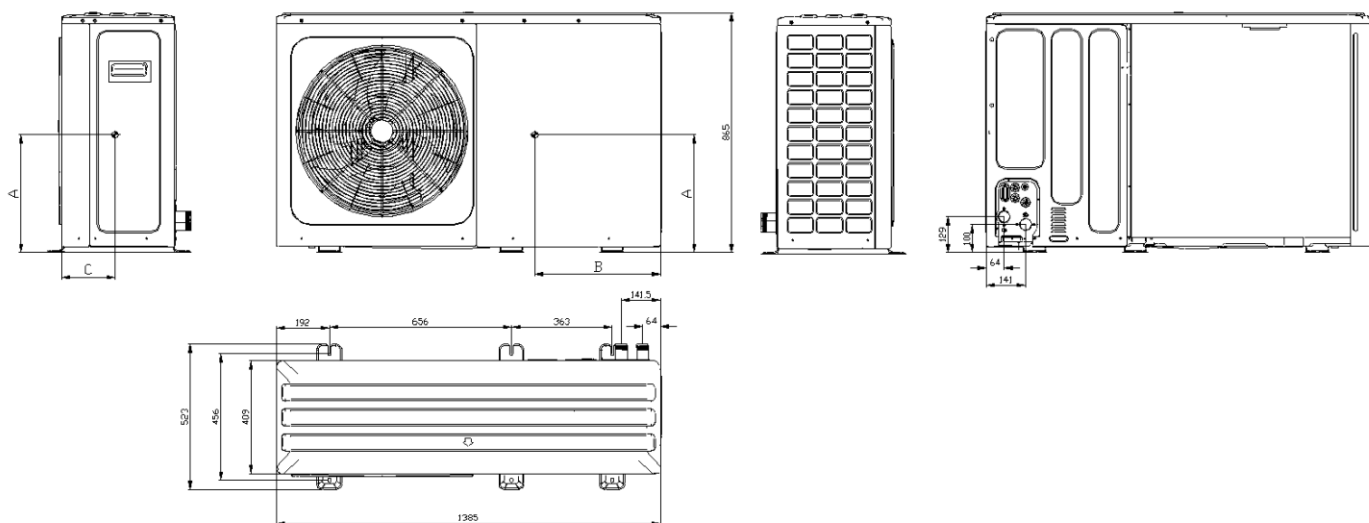

unit: mm

Model	A	B	C
10 kW	360	550	234
16 kW	415	715	200

4 Operating limits

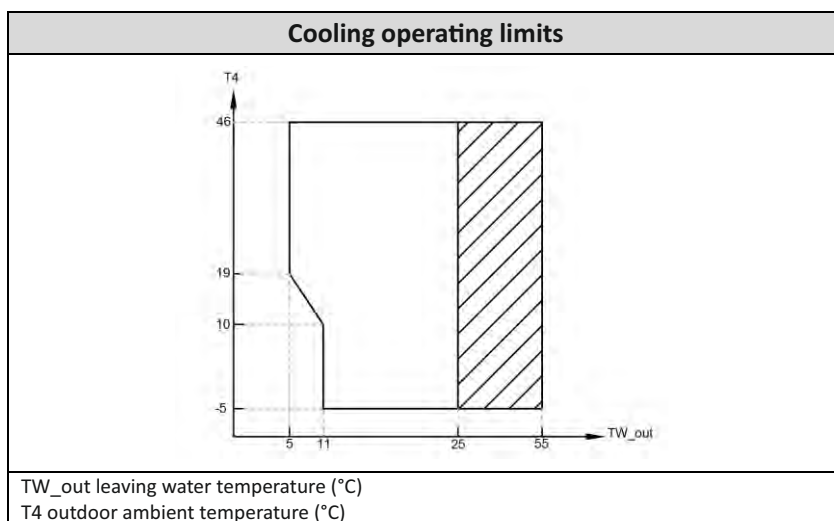
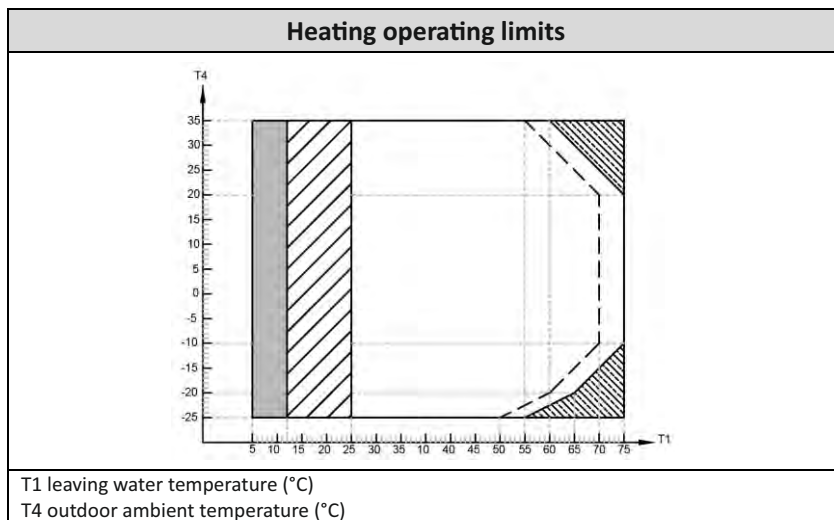

- Notes:
1. If IBH/AHS setting is valid, only IBH/AHS turns on; If IBH/AHS setting is invalid, only heat pump turns on. Limitation and protection may occur during heat pump operation.
 2. Operating range by heat pump with possible limitation and protection.
 3. Heat pump turns off, only IBH/AHS on.
 4. Maximum inlet water temperature line for heat pump operation.

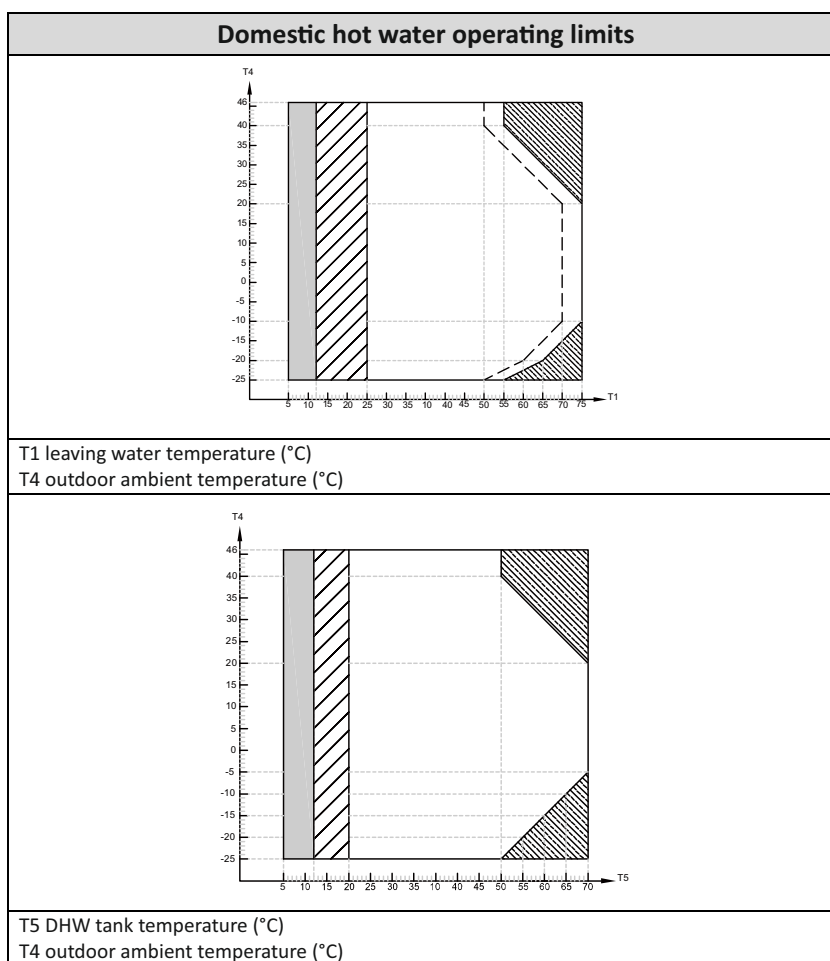

- Notes:
1. If IBH/AHS setting is valid, only IBH/AHS turns on; If IBH/AHS setting is invalid, only heat pump turns on. Limitation and protection may occur during heat pump operation.
 2. Operating range by heat pump with possible limitation and protection.
 3. Heat pump turns off, only IBH/AHS on.
 4. Maximum inlet water temperature line for heat pump operation.

5 Hydronic performance

6 kW hydronic performance¹

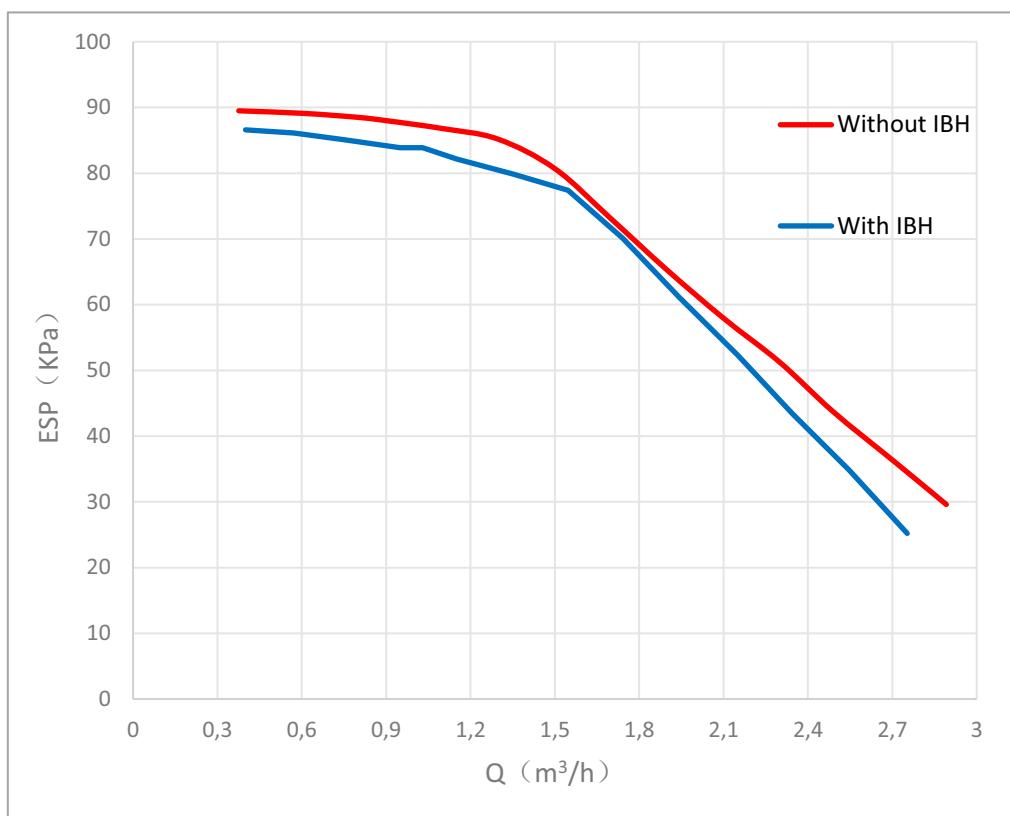

Abbreviations:

ESP: External static pressure

10 kW hydronic performance¹

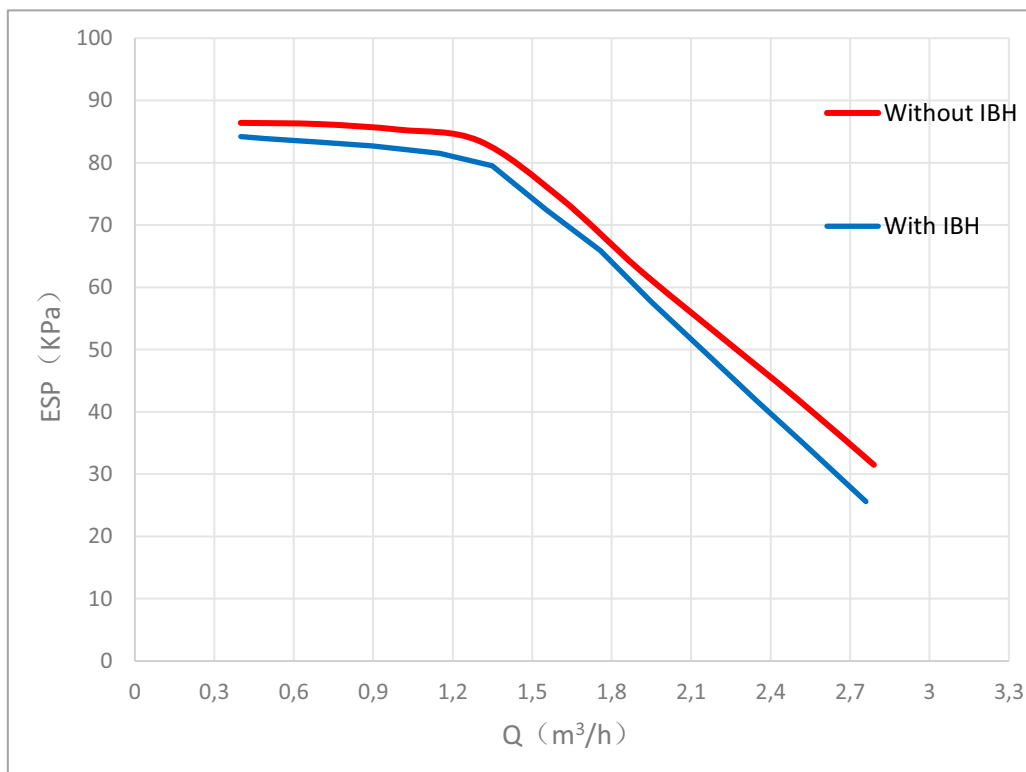

Abbreviations:

ESP: External static pressure

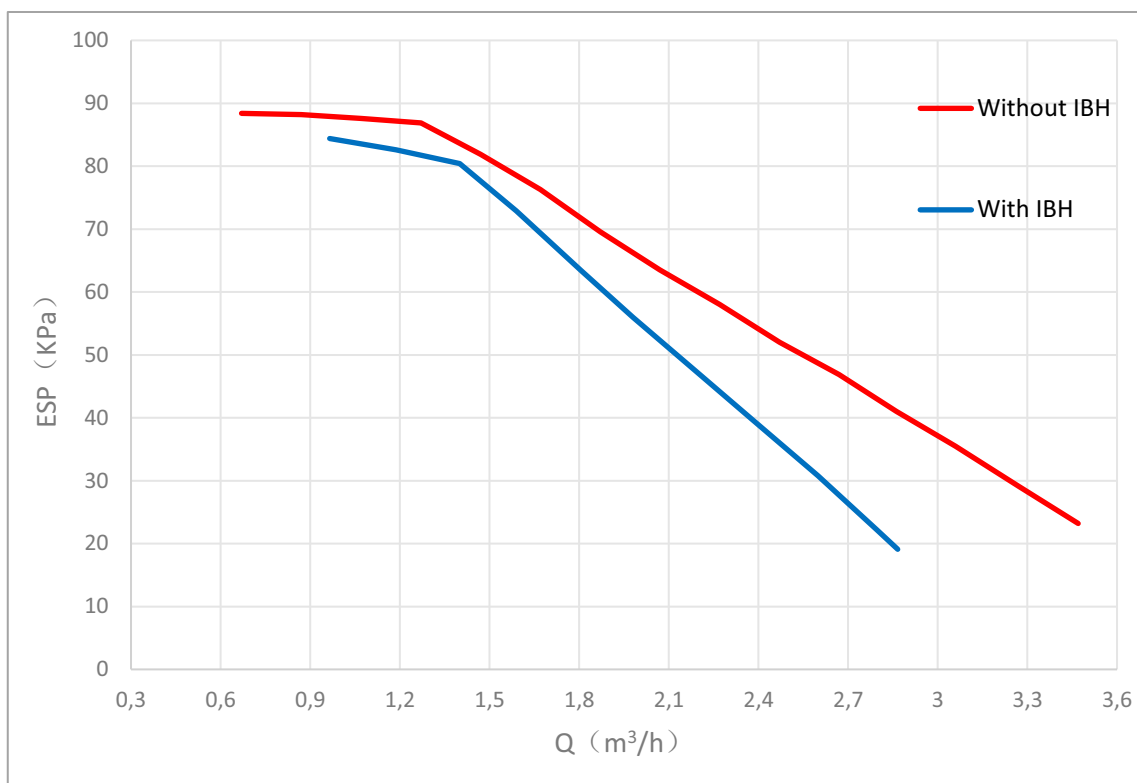
16 kW hydronic performance¹

Abbreviations:

ESP: External static pressure

6 Capacity tables

6.1 Heating capacity tables (test standard: EN14511)

6 kW heating capacity

LWT	DB	Maximum			100% (Normal)			75%			50%			25%			Minimum		
		HC	COP	PI	HC	COP	PI	HC	COP	PI	HC	COP	PI	HC	COP	PI	HC	COP	PI
25	-25	3.50	2.14	1.64	3.50	2.14	1.64	2.64	2.40	1.10	1.75	2.47	0.71	1.34	2.50	0.54	1.34	2.50	0.54
	-20	4.35	2.41	1.80	4.35	2.41	1.80	3.26	2.72	1.20	2.18	2.80	0.78	1.63	2.82	0.58	1.63	2.82	0.58
	-15	5.18	2.77	1.87	5.18	2.77	1.87	3.89	2.91	1.34	2.63	2.98	0.88	1.92	3.15	0.61	1.92	3.15	0.61
	-10	6.08	3.16	1.92	5.83	3.21	1.81	4.34	3.48	1.25	2.90	3.61	0.80	2.35	3.62	0.65	2.35	3.62	0.65
	-7	6.36	3.41	1.86	5.79	3.56	1.63	4.32	3.78	1.14	2.90	3.92	0.74	2.55	3.94	0.65	2.55	3.94	0.65
	-5	6.55	3.59	1.83	5.66	3.85	1.47	4.25	4.14	1.03	2.83	4.27	0.66	2.73	4.28	0.64	2.73	4.28	0.64
	-2	6.84	3.87	1.77	5.47	4.28	1.28	4.18	4.52	0.93	2.83	4.62	0.61	2.43	4.64	0.52	2.43	4.64	0.52
	0	6.99	4.10	1.70	5.66	4.49	1.26	4.29	4.79	0.90	2.78	4.91	0.57	2.59	4.97	0.52	2.59	4.97	0.52
	2	7.09	4.34	1.64	5.65	4.78	1.18	4.22	5.09	0.83	2.85	5.20	0.55	2.74	5.27	0.52	2.74	5.27	0.52
	5	7.72	5.06	1.53	5.85	5.65	1.03	4.41	5.85	0.75	2.90	6.07	0.48	2.79	6.08	0.46	2.79	6.08	0.46
	7	8.00	5.50	1.45	6.24	5.92	1.05	4.68	6.07	0.77	3.14	6.35	0.49	3.01	6.38	0.47	3.01	6.38	0.47
	10	7.95	5.89	1.35	6.24	6.55	0.95	4.62	6.87	0.67	3.34	7.17	0.47	3.34	7.17	0.47	3.34	7.17	0.47
	12	8.16	6.40	1.27	6.16	7.14	0.86	4.57	7.53	0.61	3.53	7.77	0.45	3.53	7.77	0.45	3.53	7.77	0.45
	15	7.92	6.79	1.17	6.27	7.39	0.85	4.65	7.81	0.60	3.62	8.14	0.44	3.62	8.14	0.44	3.62	8.14	0.44
	20	7.56	7.89	0.96	6.25	8.21	0.76	4.64	8.76	0.53	3.40	9.23	0.37	3.40	9.23	0.37	3.40	9.23	0.37
	25	7.12	9.21	0.77	6.30	9.54	0.66	4.71	10.02	0.47	3.75	10.57	0.35	3.75	10.57	0.35	3.75	10.57	0.35
30	/	/	/	/	/	/	/	/	/	/	/	/	/	/	/	/	/	/	/
35	/	/	/	/	/	/	/	/	/	/	/	/	/	/	/	/	/	/	/
30	-25	3.46	1.89	1.83	3.46	1.89	1.83	2.59	2.02	1.28	1.73	2.06	0.84	1.29	2.12	0.61	1.29	2.12	0.61
	-20	4.30	2.25	1.91	4.30	2.25	1.91	3.23	2.36	1.37	2.15	2.40	0.90	1.58	2.48	0.64	1.58	2.48	0.64
	-15	5.11	2.58	1.98	5.11	2.58	1.98	3.83	2.66	1.44	2.56	2.71	0.94	1.85	2.85	0.65	1.85	2.85	0.65
	-10	6.00	2.96	2.03	5.77	2.98	1.94	4.34	3.22	1.35	2.91	3.27	0.89	2.20	3.28	0.67	2.20	3.28	0.67
	-7	6.27	3.19	1.97	5.76	3.29	1.75	4.33	3.49	1.24	2.92	3.56	0.82	2.52	3.63	0.69	2.52	3.63	0.69
	-5	6.45	3.34	1.93	5.68	3.51	1.62	4.26	3.72	1.15	2.87	3.76	0.76	2.63	3.79	0.69	2.63	3.79	0.69
	-2	6.73	3.59	1.87	5.48	3.90	1.41	4.13	4.03	1.02	2.80	4.13	0.68	2.39	4.18	0.57	2.39	4.18	0.57
	0	6.87	3.79	1.81	5.66	4.08	1.39	4.29	4.21	1.02	2.85	4.34	0.66	2.49	4.38	0.57	2.49	4.38	0.57
	2	6.96	4.00	1.74	5.65	4.31	1.31	4.28	4.53	0.95	2.89	4.62	0.63	2.64	4.65	0.57	2.64	4.65	0.57
	5	7.58	4.64	1.63	5.87	4.99	1.18	4.36	5.15	0.85	2.91	5.28	0.55	2.79	5.37	0.52	2.79	5.37	0.52
	7	7.85	5.04	1.56	6.18	5.42	1.14	4.66	5.61	0.83	3.04	5.85	0.52	3.04	5.85	0.52	3.04	5.85	0.52
	10	8.16	5.59	1.46	6.22	6.04	1.03	4.59	6.21	0.74	3.20	6.46	0.50	3.20	6.46	0.50	3.20	6.46	0.50
	12	8.35	6.00	1.39	6.23	6.23	1.00	4.68	6.54	0.71	3.44	6.78	0.51	3.44	6.78	0.51	3.44	6.78	0.51
	15	7.74	6.05	1.28	6.25	6.45	0.97	4.64	6.78	0.68	3.50	7.02	0.50	3.50	7.02	0.50	3.50	7.02	0.50
	20	7.38	6.90	1.07	6.23	7.14	0.87	4.64	7.54	0.62	3.29	7.90	0.42	3.29	7.90	0.42	3.29	7.90	0.42
	25	7.04	7.95	0.89	6.31	8.18	0.77	4.65	8.71	0.53	3.62	9.07	0.40	3.62	9.07	0.40	3.62	9.07	0.40
30	7.07	9.19	0.77	6.17	9.24	0.67	4.65	9.56	0.49	3.98	9.77	0.41	3.98	9.77	0.41	3.98	9.77	0.41	
35	/	/	/	/	/	/	/	/	/	/	/	/	/	/	/	/	/	/	/
35	-25	3.40	1.76	1.94	3.40	1.76	1.94	2.56	1.91	1.34	1.74	1.94	0.89	1.24	2.05	0.61	1.24	2.05	0.61
	-20	4.24	2.10	2.01	4.24	2.10	2.01	3.18	2.15	1.48	2.12	2.21	0.96	1.52	2.32	0.65	1.52	2.32	0.65
	-15	5.05	2.43	2.08	5.05	2.43	2.08	3.79	2.46	1.54	2.53	2.51	1.01	1.79	2.66	0.67	1.79	2.66	0.67
	-10	5.91	2.77	2.13	5.81	2.78	2.09	4.34	2.94	1.48	2.93	2.98	0.98	2.18	3.08	0.71	2.18	3.08	0.71
	-7	6.18	2.93	2.11	5.90	2.95	2.00	4.34	3.11	1.39	2.89	3.14	0.92	2.36	3.21	0.73	2.36	3.21	0.73
	-5	6.36	3.12	2.04	5.70	3.20	1.78	4.28	3.36	1.27	2.89	3.41	0.85	2.53	3.43	0.74	2.53	3.43	0.74
	-2	6.61	3.32	1.99	5.51	3.55	1.55	4.16	3.62	1.15	2.76	3.69	0.75	2.31	3.74	0.62	2.31	3.74	0.62
	0	6.75	3.49	1.93	5.64	3.73	1.51	4.28	3.84	1.11	2.84	3.92	0.73	2.39	3.95	0.61	2.39	3.95	0.61
	2	6.83	3.67	1.86	5.60	3.90	1.44	4.17	4.12	1.01	2.76	4.18	0.66	2.53	4.19	0.60	2.53	4.19	0.60
	5	7.42	4.26	1.74	5.92	4.48	1.32	4.37	4.60	0.95	2.89	4.72	0.61	2.68	4.75	0.56	2.68	4.75	0.56
	7	7.70	4.61	1.67	6.20	4.90	1.27	4.64	5.12	0.91	3.15	5.26	0.60	2.93	5.32	0.55	2.93	5.32	0.55
	10	8.00	5.08	1.57	6.19	5.36	1.15	4.69	5.56	0.84	3.24	5.78	0.56	3.24	5.78	0.56	3.24	5.78	0.56
	12	8.17	5.43	1.50	6.24	5.77	1.08	4.63	5.97	0.78	3.45	6.22	0.56	3.45	6.22	0.56	3.45	6.22	0.56
	15	7.92	5.66	1.40	6.25	5.96	1.05	4.62	6.18	0.75	3.55	6.36	0.56	3.55	6.36	0.56	3.55	6.36	0.56
	20	7.53	6.21	1.21	5.97	6.30	0.95	4.62	6.51	0.71	3.17	6.66	0.48	3.17	6.66	0.48	3.17	6.66	0.48
	25	6.96	6.92	1.01	6.31	7.10	0.89	4.59	7.43	0.62	3.50	7.69	0.46	3.50	7.69	0.46	3.50	7.69	0.46
30	6.94	7.95	0.87	6.17	8.10	0.76	4.59	8.55	0.54	3.98	8.74	0.46	3.84	8.75	0.44	3.84	8.75	0.44	
35	7.12	9.07	0.79	6.14	9.51	0.65	4.73	9.88	0.48	4.20	10.05	0.42	4.20	10.05	0.42	4.20	10.05	0.42	
40	-25	3.34	1.65	2.03	3.34	1.65	2.03	2.51	1.82	1.38	1.73	1.86	0.93	1.26	1.95	0.65	1.26	1.95	0.65
	-20	4.17	1.98	2.11	4.17	1.98	2.11	3.20	2.06	1.55	2.08	2.09	1.00	1.54	2.22	0.69	1.54	2.22	0.69
	-15	4.96	2.21	2.24	4.96	2.21	2.24	3.72	2.31	1.61	2.48	2.33	1.06	1.82	2.46	0.74	1.82	2.46	0.74
	-10	5.83	2.53	2.30	5.60	2.61	2.15	4.21	2.67	1.58	2.82	2.72	1.04	2.16	2.75	0.79	2.16	2.75	0.79
	-7	6.07	2.78	2.19	5.59	2.79	2.00	4.22	2.92	1.44	2.77	3.01	0.92	2.39	3.07	0.78	2.39	3.07	0.78
	-5	6.22	2.88	2.16	5.56	2.94	1.89	4.22	3.04	1.39	2.79	3.07	0.91	2.56	3.20	0.80	2.56	3.20	0.80
	-2	6.48	3.06	2.11	5.45	3.24	1.68	4.11	3.33	1.24	2.80	3.35	0.83	2.57	3.36	0.76	2.57	3.36	0.76
	0	6.58	3.20	2.06	5.70	3.39	1.68	4.29	3.48	1.23	2.92	3.50	0.83	2.73	3.58	0.76	2.73	3.58	0.76
	2	6.69	3.38	1.98	5.74	3.57	1.61	4.40	3.64	1.21	2.90	3.75	0.77	2.90	3.75	0.77	2.90	3.75	0.77
	5	7.25	3.89	1.86	5.94	4.04	1.47	4.42	4.11	1.07	3.27	4.19	0.78	3.27	4.19	0.78	3.27	4.19	0.78
	7	7.53	4.20	1.79	6.35	4.31	1.47	4.70	4.40	1.07	3.58	4.52	0.79	3.58	4.52	0.79	3.58	4.52	0.79
	10	7.82	4.61	1.69	6.33	4.76	1.33	4.66	4.89	0.95	3.74	4.99	0.75	3.74	4.99	0.75	3.74	4.99	0.75
	12	8.00	4.91	1.63	6.30	5.10	1.24	4.73	5.23	0.90	3.99	5.30	0.75	3.99	5.30	0.75	3.99	5.30	0.75
	15	7.73	5.10	1.52	6.30	5.25	1.20	4.70	5.43	0.87	4.10	5.50	0.75	4.10	5.50	0.75	4.10	5.50	0.75
	20	7.35	5.62	1.31	6.33	5.75	1.10	4.70	5.86	0.80	3.70	5.98	0.62	3.70	5.98	0.62	3.70	5.98	0.62
	25	6.98	6.24	1.12	6.32	6.38	0.99	4.70											

LWT	DB	Maximum			100% (Normal)			75%			50%			25%			Minimum		
		HC	COP	PI	HC	COP	PI	HC	COP	PI	HC	COP	PI	HC	COP	PI	HC	COP	PI
45	-25	3.28	1.55	2.11	3.28	1.55	2.11	2.46	1.69	1.45	1.76	1.73	1.02	1.41	1.83	0.77	1.41	1.83	0.77
	-20	4.08	1.86	2.20	4.08	1.86	2.20	2.99	1.93	1.55	2.04	1.94	1.05	1.71	2.05	0.83	1.71	2.05	0.83
	-15	4.88	2.08	2.34	4.88	2.08	2.34	3.66	2.16	1.69	2.44	2.19	1.11	2.01	2.31	0.87	2.01	2.31	0.87
	-10	5.71	2.36	2.41	5.42	2.42	2.24	4.02	2.53	1.59	2.69	2.56	1.05	2.39	2.60	0.92	2.39	2.60	0.92
	-7	5.95	2.48	2.40	5.50	2.50	2.20	4.01	2.73	1.47	2.73	2.77	0.99	2.65	2.80	0.94	2.65	2.80	0.94
	-5	6.08	2.67	2.28	5.43	2.71	2.00	4.10	2.85	1.44	2.85	2.89	0.99	2.85	2.89	0.99	2.85	2.89	0.99
	-2	6.32	2.81	2.25	5.47	2.90	1.88	4.13	3.01	1.37	2.74	3.08	0.89	2.74	3.08	0.89	2.74	3.08	0.89
	0	6.44	2.95	2.19	5.74	3.05	1.88	4.35	3.17	1.37	2.92	3.48	0.84	2.92	3.48	0.84	2.92	3.48	0.84
	2	6.53	3.09	2.11	5.80	3.10	1.87	4.35	3.38	1.29	3.10	3.55	0.87	3.10	3.55	0.87	3.10	3.55	0.87
	5	7.07	3.40	2.08	6.06	3.60	1.68	4.54	3.63	1.25	3.65	3.65	1.00	3.50	3.74	0.94	3.50	3.74	0.94
	7	7.35	3.65	2.01	6.40	3.80	1.68	4.74	3.92	1.21	3.99	4.00	1.00	3.82	4.10	0.93	3.82	4.10	0.93
	10	7.63	4.02	1.90	6.47	4.24	1.53	4.83	4.31	1.12	4.02	4.41	0.91	4.02	4.41	0.91	4.02	4.41	0.91
	12	7.79	4.30	1.81	6.35	4.53	1.40	4.83	4.60	1.05	4.30	4.71	0.91	4.30	4.71	0.91	4.30	4.71	0.91
	15	7.52	4.42	1.70	6.51	4.66	1.40	4.83	4.72	1.02	4.41	4.85	0.91	4.41	4.85	0.91	4.41	4.85	0.91
	20	7.14	4.85	1.47	6.50	5.04	1.29	4.81	5.11	0.94	4.04	5.28	0.77	4.04	5.28	0.77	4.04	5.28	0.77
	25	6.78	5.61	1.21	6.41	5.68	1.13	4.78	5.73	0.83	4.46	5.87	0.76	4.46	5.87	0.76	4.46	5.87	0.76
30	6.91	6.31	1.10	6.47	6.35	1.02	4.92	6.54	0.75	4.92	6.54	0.75	4.92	6.54	0.75	4.92	6.54	0.75	
35	6.78	6.75	1.01	6.44	6.76	0.95	5.16	6.94	0.74	5.16	6.94	0.74	5.16	6.94	0.74	5.16	6.94	0.74	
50	-25	3.20	1.46	2.19	3.20	1.46	2.19	2.40	1.60	1.50	1.85	1.62	1.14	1.52	1.66	0.92	1.52	1.66	0.92
	-20	3.98	1.74	2.29	3.98	1.74	2.29	2.99	1.79	1.67	1.99	1.85	1.08	1.81	1.88	0.96	1.81	1.88	0.96
	-15	4.75	1.90	2.50	4.75	1.90	2.50	3.56	1.98	1.80	2.37	2.00	1.19	2.12	2.06	1.03	2.12	2.06	1.03
	-10	5.57	2.13	2.62	5.23	2.16	2.42	3.96	2.30	1.72	2.52	2.37	1.06	2.52	2.37	1.06	2.52	2.37	1.06
	-7	5.80	2.28	2.55	5.26	2.29	2.30	3.95	2.46	1.61	2.77	2.55	1.09	2.77	2.55	1.09	2.77	2.55	1.09
	-5	5.94	2.46	2.41	5.29	2.49	2.12	4.03	2.58	1.56	2.99	2.63	1.13	2.99	2.63	1.13	2.99	2.63	1.13
	-2	6.17	2.59	2.38	5.37	2.67	2.01	4.06	2.72	1.49	3.04	2.79	1.09	3.04	2.79	1.09	3.04	2.79	1.09
	0	6.28	2.70	2.33	5.69	2.79	2.04	4.32	2.85	1.51	3.24	2.94	1.10	3.24	2.94	1.10	3.24	2.94	1.10
	2	6.37	2.83	2.25	5.74	2.88	1.99	4.36	2.99	1.46	3.40	3.03	1.12	3.40	3.03	1.12	3.40	3.03	1.12
	5	6.92	3.12	2.22	5.96	3.21	1.85	4.44	3.30	1.34	3.90	3.34	1.17	3.90	3.34	1.17	3.90	3.34	1.17
	7	7.00	3.44	2.04	6.29	3.40	1.85	4.69	3.52	1.33	4.26	3.58	1.19	4.26	3.58	1.19	4.26	3.58	1.19
	10	7.28	3.71	1.96	6.28	3.72	1.69	4.76	3.88	1.23	4.30	3.92	1.10	4.30	3.92	1.10	4.30	3.92	1.10
	12	7.44	3.92	1.90	6.37	3.98	1.60	4.63	4.12	1.13	4.60	4.16	1.11	4.60	4.16	1.11	4.60	4.16	1.11
	15	7.19	4.04	1.78	6.42	4.15	1.55	4.77	4.25	1.12	4.73	4.29	1.10	4.73	4.29	1.10	4.73	4.29	1.10
	20	6.80	4.37	1.56	6.42	4.40	1.46	4.76	4.54	1.05	4.13	4.59	0.90	4.13	4.59	0.90	4.13	4.59	0.90
	25	6.59	4.90	1.34	6.34	4.93	1.29	4.75	5.04	0.94	4.56	5.08	0.90	4.56	5.08	0.90	4.56	5.08	0.90
30	6.57	5.42	1.21	6.41	5.50	1.17	5.03	5.71	0.88	5.03	5.71	0.88	5.03	5.71	0.88	5.03	5.71	0.88	
35	6.75	6.00	1.13	6.21	6.12	1.01	5.55	6.19	0.90	5.54	6.22	0.89	5.54	6.22	0.89	5.54	6.22	0.89	
55	-25	3.00	1.40	2.14	3.00	1.40	2.14	2.25	1.44	1.56	1.55	1.50	1.03	1.55	1.50	1.03	1.55	1.50	1.03
	-20	3.66	1.57	2.34	3.66	1.57	2.34	2.77	1.63	1.70	1.87	1.69	1.11	1.87	1.69	1.11	1.87	1.69	1.11
	-15	4.46	1.71	2.61	4.46	1.71	2.61	3.34	1.79	1.87	2.19	1.85	1.18	2.19	1.85	1.18	2.19	1.85	1.18
	-10	5.23	1.91	2.74	5.12	1.92	2.67	3.81	1.99	1.92	2.59	2.04	1.27	2.59	2.04	1.27	2.59	2.04	1.27
	-7	5.47	2.13	2.57	5.20	2.15	2.42	3.74	2.16	1.73	2.86	2.20	1.30	2.86	2.20	1.30	2.86	2.20	1.30
	-5	5.59	2.15	2.60	5.17	2.20	2.35	3.88	2.27	1.71	3.07	2.30	1.33	3.07	2.30	1.33	3.07	2.30	1.33
	-2	5.81	2.30	2.53	5.28	2.35	2.24	4.01	2.51	1.60	3.25	2.57	1.27	3.25	2.57	1.27	3.25	2.57	1.27
	0	6.16	2.50	2.46	5.34	2.60	2.06	4.04	2.63	1.53	3.49	2.65	1.32	3.49	2.65	1.32	3.49	2.65	1.32
	2	6.22	2.60	2.39	5.80	2.65	2.19	4.41	2.72	1.62	3.67	2.73	1.34	3.67	2.73	1.34	3.67	2.73	1.34
	5	6.72	2.88	2.33	5.99	2.95	2.03	4.42	3.04	1.46	4.17	3.05	1.37	4.17	3.05	1.37	4.17	3.05	1.37
	7	6.97	3.00	2.32	6.20	3.10	2.00	4.72	3.19	1.48	4.55	3.23	1.41	4.55	3.23	1.41	4.55	3.23	1.41
	10	7.24	3.32	2.18	6.22	3.40	1.83	4.59	3.48	1.32	4.26	3.53	1.21	4.26	3.53	1.21	4.26	3.53	1.21
	12	7.40	3.52	2.10	6.20	3.58	1.73	4.69	3.69	1.27	4.55	3.74	1.22	4.55	3.74	1.22	4.55	3.74	1.22
	15	7.14	3.67	1.95	6.25	3.72	1.68	4.83	3.80	1.27	4.68	3.85	1.22	4.68	3.85	1.22	4.68	3.85	1.22
	20	6.77	3.95	1.71	6.24	3.98	1.57	4.60	4.06	1.13	4.11	4.07	1.01	4.11	4.07	1.01	4.11	4.07	1.01
	25	6.39	4.32	1.48	6.26	4.35	1.44	4.71	4.51	1.04	4.56	4.55	1.00	4.56	4.55	1.00	4.56	4.55	1.00
30	6.50	4.72	1.38	6.22	4.75	1.31	5.03	4.91	1.02	5.03	4.91	1.02	5.03	4.91	1.02	5.03	4.91	1.02	
35	6.69	4.95	1.35	6.18	4.98	1.24	5.54	5.08	1.09	5.54	5.08	1.09	5.54	5.08	1.09	5.54	5.08	1.09	
60	-25	/	/	/	/	/	/	/	/	/	/	/	/	/	/	/	/	/	/
	-20	3.60	1.41	2.55	3.60	1.41	2.55	2.70	1.50	1.81	1.94	1.53	1.27	1.94	1.53	1.27	1.94	1.53	1.27
	-15	4.31	1.60	2.70	4.31	1.60	2.70	3.23	1.65	1.97	2.27	1.69	1.35	2.27	1.69	1.35	2.27	1.69	1.35
	-10	5.05	1.78	2.83	5.05	1.78	2.83	3.83	1.83	2.10	2.67	1.86	1.43	2.67	1.86	1.43	2.67	1.86	1.43
	-7	5.27	1.84	2.87	5.10	1.86	2.74	3.79	1.94	1.95	2.94	1.99	1.48	2.94	1.99	1.48	2.94	1.99	1.48
	-5	5.39	1.90	2.84	5.15	1.91	2.70	3.93	2.05	1.92	3.16	2.13	1.48	3.16	2.13	1.48	3.16	2.13	1.48
	-2	5.61	2.01	2.79	5.29	2.04	2.60	3.99	2.29	1.74	3.10	2.36	1.31	3.10	2.36	1.31	3.10	2.36	1.31
	0	5.92	2.17	2.73	5.66	2.22	2.55	4.29	2.36	1.82	3.31	2.42	1.37	3.31	2.42	1.37	3.31	2.42	1.37

LWT	DB	Maximum			100% (Normal)			75%			50%			25%			Minimum		
		HC	COP	PI	HC	COP	PI	HC	COP	PI	HC	COP	PI	HC	COP	PI	HC	COP	PI
65	-25	/	/	/	/	/	/	/	/	/	/	/	/	/	/	/	/	/	/
	-20	3.44	1.29	2.66	3.44	1.29	2.66	2.58	1.37	1.89	1.86	1.39	1.34	1.86	1.39	1.34	1.86	1.39	1.34
	-15	4.12	1.38	2.99	4.12	1.38	2.99	3.09	1.50	2.06	2.16	1.51	1.43	2.16	1.51	1.43	2.16	1.51	1.43
	-10	4.83	1.56	3.10	4.83	1.56	3.10	3.61	1.65	2.18	2.55	1.69	1.51	2.55	1.69	1.51	2.55	1.69	1.51
	-7	5.05	1.69	2.99	5.05	1.69	2.99	3.81	1.73	2.20	2.79	1.79	1.56	2.79	1.79	1.56	2.79	1.79	1.56
	-5	4.93	1.76	2.80	4.93	1.76	2.80	3.77	1.84	2.05	3.00	1.88	1.59	3.00	1.88	1.59	3.00	1.88	1.59
	-2	5.31	1.89	2.81	5.31	1.89	2.81	4.02	2.12	1.89	2.91	2.15	1.36	2.91	2.15	1.36	2.91	2.15	1.36
	0	5.68	1.96	2.90	5.35	1.99	2.68	4.05	2.17	1.87	3.11	2.20	1.41	3.11	2.20	1.41	3.11	2.20	1.41
	2	5.78	2.04	2.84	5.41	2.07	2.61	4.13	2.20	1.88	3.29	2.22	1.48	3.29	2.22	1.48	3.29	2.22	1.48
	5	6.23	2.30	2.71	5.96	2.32	2.57	4.44	2.43	1.83	3.74	2.46	1.52	3.74	2.46	1.52	3.74	2.46	1.52
	7	6.46	2.45	2.64	6.19	2.47	2.51	4.63	2.57	1.80	4.10	2.59	1.58	4.10	2.59	1.58	4.10	2.59	1.58
	10	6.68	2.60	2.57	6.22	2.63	2.37	4.58	2.75	1.67	3.94	2.80	1.41	3.94	2.80	1.41	3.94	2.80	1.41
	12	6.82	2.72	2.51	6.20	2.75	2.25	4.58	2.85	1.60	4.21	2.89	1.46	4.21	2.89	1.46	4.21	2.89	1.46
	15	6.57	2.80	2.35	6.25	2.82	2.22	4.72	2.90	1.63	4.33	2.97	1.46	4.33	2.97	1.46	4.33	2.97	1.46
	20	6.18	3.05	2.03	6.18	3.05	2.03	4.64	3.15	1.47	3.66	3.17	1.16	3.66	3.17	1.16	3.66	3.17	1.16
	25	5.74	3.27	1.76	5.74	3.27	1.76	4.55	3.38	1.34	4.05	3.41	1.19	4.05	3.41	1.19	4.05	3.41	1.19
30	5.78	3.55	1.63	5.78	3.55	1.63	4.66	3.70	1.26	4.47	3.75	1.19	4.47	3.75	1.19	4.47	3.75	1.19	
35	/	/	/	/	/	/	/	/	/	/	/	/	/	/	/	/	/	/	/
70	-25	/	/	/	/	/	/	/	/	/	/	/	/	/	/	/	/	/	/
	-20	/	/	/	/	/	/	/	/	/	/	/	/	/	/	/	/	/	/
	-15	3.96	1.30	3.04	3.96	1.30	3.04	2.97	1.38	2.16	2.05	1.48	1.39	2.05	1.48	1.39	2.05	1.48	1.39
	-10	4.18	1.39	3.00	4.18	1.39	3.00	3.13	1.48	2.12	2.54	1.57	1.62	2.54	1.57	1.62	2.54	1.57	1.62
	-7	4.48	1.48	3.03	4.48	1.48	3.03	3.44	1.59	2.16	2.83	1.63	1.74	2.83	1.63	1.74	2.83	1.63	1.74
	-5	4.50	1.54	2.91	4.50	1.54	2.91	3.62	1.65	2.19	2.77	1.79	1.55	2.77	1.79	1.55	2.77	1.79	1.55
	-2	5.13	1.70	3.01	5.13	1.70	3.01	4.01	1.93	2.08	2.69	2.13	1.26	2.69	2.13	1.26	2.69	2.13	1.26
	0	5.35	1.76	3.04	5.35	1.76	3.04	4.05	1.98	2.04	2.88	2.16	1.33	2.88	2.16	1.33	2.88	2.16	1.33
	2	5.44	1.83	2.97	5.44	1.83	2.97	4.12	2.10	1.96	3.05	2.25	1.36	3.05	2.25	1.36	3.05	2.25	1.36
	5	5.92	1.95	3.04	5.92	1.95	3.04	4.44	2.20	2.02	3.38	2.40	1.41	3.38	2.40	1.41	3.38	2.40	1.41
	7	6.27	2.23	2.81	6.27	2.23	2.81	4.64	2.40	1.93	3.80	2.51	1.51	3.80	2.51	1.51	3.80	2.51	1.51
	10	6.19	2.38	2.60	6.19	2.38	2.60	4.68	2.49	1.88	3.60	2.71	1.33	3.60	2.71	1.33	3.60	2.71	1.33
	12	6.18	2.48	2.49	6.18	2.48	2.49	4.64	2.68	1.73	3.85	2.83	1.36	3.85	2.83	1.36	3.85	2.83	1.36
	15	6.34	2.52	2.52	6.34	2.52	2.52	4.66	2.70	1.72	3.96	2.87	1.38	3.96	2.87	1.38	3.96	2.87	1.38
	20	5.94	2.59	2.29	5.94	2.59	2.29	4.45	2.81	1.58	3.36	2.93	1.15	3.36	2.93	1.15	3.36	2.93	1.15
	25	5.41	2.72	1.99	5.41	2.72	1.99	4.06	2.91	1.39	3.72	2.97	1.25	3.72	2.97	1.25	3.72	2.97	1.25
30	/	/	/	/	/	/	/	/	/	/	/	/	/	/	/	/	/	/	/
35	/	/	/	/	/	/	/	/	/	/	/	/	/	/	/	/	/	/	/
75	-25	/	/	/	/	/	/	/	/	/	/	/	/	/	/	/	/	/	/
	-20	/	/	/	/	/	/	/	/	/	/	/	/	/	/	/	/	/	/
	-15	/	/	/	/	/	/	/	/	/	/	/	/	/	/	/	/	/	/
	-10	3.81	1.26	3.02	3.81	1.26	3.02	2.88	1.37	2.10	2.22	1.48	1.50	2.22	1.48	1.50	2.22	1.48	1.50
	-7	4.09	1.29	3.17	4.09	1.29	3.17	3.07	1.39	2.20	2.40	1.51	1.59	2.40	1.51	1.59	2.40	1.51	1.59
	-5	4.60	1.34	3.43	4.60	1.34	3.43	3.47	1.48	2.34	2.71	1.57	1.73	2.71	1.57	1.73	2.71	1.57	1.73
	-2	4.67	1.50	3.11	4.67	1.50	3.11	3.54	1.63	2.17	2.42	1.81	1.34	2.42	1.81	1.34	2.42	1.81	1.34
	0	5.06	1.51	3.34	5.06	1.51	3.34	3.83	1.72	2.22	2.59	1.86	1.39	2.59	1.86	1.39	2.59	1.86	1.39
	2	5.17	1.58	3.27	5.17	1.58	3.27	3.92	1.78	2.20	2.74	1.90	1.44	2.74	1.90	1.44	2.74	1.90	1.44
	5	5.60	1.80	3.11	5.60	1.80	3.11	4.20	1.99	2.11	3.09	2.20	1.41	3.09	2.20	1.41	3.09	2.20	1.41
	7	5.84	1.95	3.00	5.84	1.95	3.00	4.38	2.11	2.08	3.45	2.28	1.51	3.45	2.28	1.51	3.45	2.28	1.51
	10	6.03	2.00	3.02	6.03	2.00	3.02	4.52	2.23	2.03	3.47	2.45	1.42	3.47	2.45	1.42	3.47	2.45	1.42
	12	6.12	2.12	2.89	6.12	2.12	2.89	4.69	2.29	2.05	3.45	2.48	1.39	3.45	2.48	1.39	3.45	2.48	1.39
	15	5.91	2.20	2.69	5.91	2.20	2.69	4.50	2.34	1.92	3.47	2.52	1.38	3.47	2.52	1.38	3.47	2.52	1.38
	20	5.46	2.22	2.46	5.46	2.22	2.46	4.09	2.42	1.69	2.96	2.63	1.13	2.96	2.63	1.13	2.96	2.63	1.13
	25	/	/	/	/	/	/	/	/	/	/	/	/	/	/	/	/	/	/
30	/	/	/	/	/	/	/	/	/	/	/	/	/	/	/	/	/	/	/
35	/	/	/	/	/	/	/	/	/	/	/	/	/	/	/	/	/	/	/

Abbreviations:

LWT: Leaving water temperature (°C)

DB: Dry-bulb temperature for Outdoor air temperature (°C)

HC: Total heating capacity (kW)

PI: Power input (kW)

10 kW heating capacity

LWT	DB	Maximum			100% (Normal)			75%			50%			25%			Minimum		
		HC	COP	PI	HC	COP	PI	HC	COP	PI	HC	COP	PI	HC	COP	PI	HC	COP	PI
25	-25	5.55	2.14	2.59	5.55	2.14	2.59	4.16	2.48	1.83	2.75	2.77	1.17	2.19	2.85	0.77	2.19	2.85	0.77
	-20	6.71	2.34	2.87	6.71	2.34	2.87	5.03	2.67	1.88	3.34	3.00	1.23	2.61	3.10	0.84	2.61	3.10	0.84
	-15	7.66	2.70	2.83	7.66	2.70	2.83	5.74	3.01	1.93	3.83	3.45	1.24	3.05	3.56	0.85	3.05	3.56	0.85
	-10	8.76	3.05	2.87	8.05	3.34	2.41	6.06	3.74	1.60	4.04	4.17	1.03	3.36	4.25	0.79	3.36	4.25	0.79
	-7	9.12	3.26	2.80	8.03	3.60	2.23	6.11	3.95	1.56	4.12	4.40	0.97	3.80	4.42	0.86	3.80	4.42	0.86
	-5	9.34	3.45	2.71	8.03	3.81	2.11	6.09	4.22	1.44	4.12	4.61	0.89	4.07	4.62	0.88	4.07	4.62	0.88
	-2	9.70	3.90	2.49	8.09	4.28	1.89	6.11	4.71	1.30	4.10	5.20	0.79	3.64	5.25	0.69	3.64	5.25	0.69
	0	9.68	4.08	2.37	8.20	4.44	1.84	6.15	4.85	1.27	4.13	5.28	0.78	3.82	5.31	0.72	3.82	5.31	0.72
	2	9.84	4.37	2.25	8.21	4.78	1.72	6.21	5.22	1.19	4.17	5.70	0.73	4.03	5.71	0.71	4.03	5.71	0.71
	5	10.73	5.28	2.03	8.80	5.69	1.55	6.65	6.13	1.08	4.50	6.51	0.69	4.23	6.52	0.65	4.23	6.52	0.65
	7	11.46	5.70	2.01	9.97	6.26	1.59	7.48	6.70	1.12	5.07	7.06	0.72	4.62	7.15	0.65	4.62	7.15	0.65
	10	11.86	6.65	1.78	9.67	7.22	1.34	7.41	7.66	0.97	5.08	8.11	0.63	5.08	8.11	0.63	5.08	8.11	0.63
	12	12.16	7.55	1.61	9.70	8.21	1.18	7.44	8.59	0.87	5.42	9.01	0.60	5.42	9.01	0.60	5.42	9.01	0.60
	15	11.93	7.92	1.51	9.54	8.55	1.12	7.15	9.11	0.78	5.50	9.46	0.58	5.50	9.46	0.58	5.50	9.46	0.58
	20	11.73	8.77	1.34	9.62	9.33	1.03	7.21	9.75	0.74	5.17	10.24	0.50	5.17	10.24	0.50	5.17	10.24	0.50
	25	11.87	9.45	1.26	9.67	9.98	0.97	7.19	10.51	0.68	5.70	10.83	0.48	5.70	10.83	0.53	5.70	10.83	0.53
30	/	/	/	/	/	/	/	/	/	/	/	/	/	/	/	/	/	/	/
35	/	/	/	/	/	/	/	/	/	/	/	/	/	/	/	/	/	/	/
30	-25	5.46	2.01	2.71	5.46	2.01	2.71	4.09	2.30	1.78	2.69	2.58	1.04	2.14	2.64	0.81	2.14	2.64	0.81
	-20	6.62	2.31	2.86	6.62	2.31	2.86	4.97	2.59	1.92	3.26	2.87	1.13	2.56	3.01	0.85	2.56	3.01	0.85
	-15	7.57	2.54	2.98	7.57	2.54	2.98	5.67	2.85	1.99	3.78	3.18	1.19	3.00	3.30	0.91	3.00	3.30	0.91
	-10	8.65	2.86	3.03	8.05	2.94	2.73	6.06	3.28	1.85	4.04	3.65	1.11	3.26	3.80	0.86	3.26	3.80	0.86
	-7	9.00	3.06	2.94	8.03	3.20	2.51	6.11	3.60	1.70	4.12	3.93	1.05	3.70	4.04	0.92	3.70	4.04	0.92
	-5	9.24	3.23	2.86	8.03	3.45	2.33	6.09	3.84	1.59	4.12	4.20	0.98	3.98	4.35	0.92	3.98	4.35	0.92
	-2	9.60	3.48	2.76	8.04	3.86	2.08	6.14	4.22	1.45	4.16	4.57	0.91	3.56	4.70	0.76	3.56	4.70	0.76
	0	9.56	3.68	2.60	8.20	4.00	2.05	6.20	4.34	1.43	4.20	4.73	0.89	3.73	4.92	0.76	3.73	4.92	0.76
	2	9.70	3.91	2.48	8.21	4.27	1.92	6.26	4.63	1.35	4.25	5.02	0.85	3.94	5.18	0.76	3.94	5.18	0.76
	5	10.56	4.49	2.35	8.77	4.82	1.82	6.62	5.27	1.25	4.53	5.69	0.80	4.13	5.87	0.70	4.13	5.87	0.70
	7	11.24	4.82	2.33	9.92	5.16	1.92	7.46	5.68	1.31	4.96	5.97	0.83	4.52	6.12	0.74	4.52	6.12	0.74
	10	11.65	5.50	2.12	9.66	5.94	1.63	7.38	6.36	1.16	4.98	6.79	0.73	4.98	6.79	0.73	4.98	6.79	0.73
	12	11.95	5.85	2.04	9.71	6.28	1.55	7.45	6.55	1.14	5.32	7.12	0.75	5.32	7.12	0.75	5.32	7.12	0.75
	15	11.73	6.35	1.85	9.53	6.78	1.41	7.17	7.22	0.99	5.41	7.59	0.71	5.41	7.59	0.71	5.41	7.59	0.71
	20	11.56	7.33	1.58	9.62	7.77	1.24	7.24	8.01	0.90	5.06	8.30	0.61	5.06	8.30	0.61	5.06	8.30	0.61
	25	11.71	8.45	1.39	9.68	8.80	1.10	7.25	9.50	0.76	5.61	9.75	0.58	5.61	9.75	0.58	5.61	9.75	0.58
30	11.47	9.49	1.21	9.57	10.06	0.95	7.35	10.48	0.70	6.16	11.02	0.56	6.16	11.02	0.56	6.16	11.02	0.56	
35	/	/	/	/	/	/	/	/	/	/	/	/	/	/	/	/	/	/	/
35	-25	5.37	1.92	2.80	5.37	1.92	2.80	3.96	2.01	1.97	2.62	2.20	1.19	2.09	2.35	0.89	2.09	2.35	0.89
	-20	6.54	2.19	2.99	6.54	2.19	2.99	4.83	2.27	2.13	3.22	2.57	1.25	2.50	2.64	0.95	2.50	2.64	0.95
	-15	7.45	2.39	3.12	7.45	2.39	3.12	5.78	2.50	2.31	3.88	2.72	1.43	2.91	2.96	0.98	2.91	2.96	0.98
	-10	8.54	2.69	3.18	7.60	2.82	2.70	5.74	3.01	1.91	3.92	3.12	1.26	3.16	3.28	0.96	3.16	3.28	0.96
	-7	8.89	2.78	3.20	8.00	2.85	2.81	6.00	3.22	1.86	4.00	3.45	1.16	3.60	3.52	1.02	3.60	3.52	1.02
	-5	9.12	3.04	3.00	8.00	3.22	2.49	6.32	3.49	1.81	4.24	3.71	1.14	3.88	3.72	1.04	3.88	3.72	1.04
	-2	9.49	3.29	2.88	8.02	3.55	2.26	6.40	3.83	1.67	4.26	4.05	1.05	3.47	4.16	0.84	3.47	4.16	0.84
	0	9.42	3.37	2.80	8.06	3.65	2.21	6.55	3.90	1.68	4.36	4.18	1.04	3.66	4.37	0.84	3.66	4.37	0.84
	2	9.57	3.55	2.69	8.20	3.65	2.25	6.10	4.03	1.52	4.18	4.44	0.94	3.84	4.48	0.86	3.84	4.48	0.86
	5	10.40	4.00	2.60	8.81	4.35	2.02	6.59	4.70	1.40	4.53	5.12	0.88	4.01	5.16	0.78	4.01	5.16	0.78
	7	11.05	4.40	2.51	10.00	4.70	2.13	7.50	5.12	1.47	4.97	5.52	0.90	4.40	5.64	0.78	4.40	5.64	0.78
	10	11.44	4.93	2.32	9.63	5.32	1.81	7.37	5.71	1.29	5.02	6.40	0.78	4.86	6.43	0.76	4.86	6.43	0.76
	12	11.73	5.43	2.16	9.70	5.81	1.67	7.43	6.26	1.19	5.19	6.61	0.79	5.19	6.61	0.79	5.19	6.61	0.79
	15	11.53	5.66	2.04	9.82	6.03	1.63	7.16	6.44	1.11	5.31	6.90	0.77	5.31	6.90	0.77	5.31	6.90	0.77
	20	11.35	6.40	1.78	9.60	6.67	1.44	7.25	7.11	1.02	4.92	7.57	0.65	4.92	7.57	0.65	4.92	7.57	0.65
	25	11.48	7.46	1.54	9.66	7.84	1.23	7.28	8.19	0.89	5.46	8.64	0.63	5.46	8.64	0.63	5.46	8.64	0.63
30	11.25	8.83	1.27	9.66	9.25	1.04	7.21	9.69	0.74	6.00	10.06	0.60	6.00	10.06	0.60	6.00	10.06	0.60	
35	10.81	9.95	1.09	9.67	10.92	0.89	7.41	10.95	0.68	6.60	11.13	0.59	6.60	11.13	0.59	6.60	11.13	0.59	
40	-25	5.29	1.64	3.23	5.29	1.64	3.23	3.88	1.72	2.25	2.56	2.08	1.23	2.14	2.19	0.98	2.14	2.19	0.98
	-20	6.46	2.10	3.08	6.46	2.10	3.08	4.89	2.21	2.21	3.19	2.40	1.33	2.52	2.47	1.02	2.52	2.47	1.02
	-15	7.35	2.25	3.28	7.35	2.25	3.28	5.65	2.33	2.42	3.77	2.72	1.39	2.98	2.86	1.04	2.98	2.86	1.04
	-10	8.43	2.51	3.35	7.86	2.62	3.00	5.90	2.76	2.14	3.94	2.97	1.32	3.21	3.10	1.03	3.21	3.10	1.03
	-7	8.78	2.70	3.25	7.84	2.85	2.75	5.97	3.05	1.96	4.01	3.35	1.20	3.65	3.40	1.07	3.65	3.40	1.07
	-5	9.10	2.86	3.19	7.89	3.00	2.63	5.92	3.26	1.82	4.01	3.54	1.13	3.95	3.57	1.10	3.95	3.57	1.10
	-2	9.39	3.09	3.04	7.98	3.27	2.44	6.05	3.53	1.71	3.98	3.79	1.05	3.98	3.79	1.05	3.98	3.79	1.05
	0	9.29	3.15	2.95	8.05	3.31	2.43	6.09	3.59	1.69	4.10	3.84	1.07	4.10	3.84	1.07	4.10	3.84	1.07
	2	9.43	3.31	2.85</															

LWT	DB	Maximum			100% (Normal)			75%			50%			25%			Minimum		
		HC	COP	PI	HC	COP	PI	HC	COP	PI	HC	COP	PI	HC	COP	PI	HC	COP	PI
45	-25	5.21	1.59	3.27	5.21	1.59	3.27	3.91	1.66	2.36	2.59	1.82	1.42	2.38	1.85	1.29	2.38	1.85	1.29
	-20	6.41	1.89	3.39	6.24	1.91	3.27	4.71	1.95	2.42	3.16	2.16	1.46	2.65	2.20	1.20	2.65	2.20	1.20
	-15	7.24	2.08	3.47	7.24	2.08	3.47	5.52	2.16	2.55	3.72	2.21	1.69	2.88	2.50	1.15	2.88	2.50	1.15
	-10	8.32	2.16	3.86	7.45	2.23	3.34	5.59	2.56	2.18	3.72	2.67	1.39	3.59	2.68	1.34	3.59	2.68	1.34
	-7	8.67	2.21	3.92	7.60	2.25	3.38	5.71	2.63	2.17	4.09	2.93	1.40	4.09	2.93	1.40	4.09	2.93	1.40
	-5	9.08	2.44	3.71	7.64	2.63	2.90	5.81	2.99	1.94	4.38	3.10	1.41	4.38	3.10	1.41	4.38	3.10	1.41
	-2	9.34	2.66	3.50	7.65	2.78	2.75	5.82	3.17	1.83	4.25	3.30	1.29	4.25	3.30	1.29	4.25	3.30	1.29
	0	9.16	2.68	3.42	7.70	2.84	2.71	5.86	3.23	1.81	4.34	3.33	1.30	4.34	3.33	1.30	4.34	3.33	1.30
	2	9.29	2.86	3.25	8.20	2.95	2.78	6.12	3.33	1.84	4.62	3.51	1.31	4.62	3.51	1.31	4.62	3.51	1.31
	5	9.92	3.34	2.97	8.82	3.47	2.54	6.60	3.72	1.77	5.04	3.82	1.32	5.04	3.82	1.32	5.04	3.82	1.32
	7	10.47	3.45	3.04	10.00	3.65	2.74	7.50	4.00	1.87	5.52	4.25	1.30	5.52	4.25	1.30	5.52	4.25	1.30
	10	10.81	3.99	2.71	9.68	4.14	2.34	7.41	4.44	1.67	5.87	4.60	1.28	5.87	4.60	1.28	5.87	4.60	1.28
	12	11.08	4.27	2.59	9.63	4.49	2.15	7.32	4.82	1.52	6.28	4.92	1.28	6.28	4.92	1.28	6.28	4.92	1.28
	15	10.87	4.47	2.43	9.65	4.68	2.06	7.28	4.98	1.46	6.35	5.08	1.25	6.35	5.08	1.25	6.35	5.08	1.25
	20	10.67	4.97	2.15	9.75	5.11	1.91	7.20	5.47	1.32	5.93	5.66	1.05	5.93	5.66	1.05	5.93	5.66	1.05
	25	10.79	5.57	1.94	9.57	5.78	1.65	7.29	6.23	1.17	6.56	6.33	1.04	6.56	6.33	1.04	6.56	6.33	1.04
30	10.54	6.41	1.64	9.75	6.58	1.48	7.24	7.11	1.02	7.24	7.11	1.02	7.24	7.11	1.02	7.24	7.11	1.02	
35	10.09	7.50	1.35	9.63	7.59	1.27	7.95	8.01	0.99	7.95	8.01	0.99	7.95	8.01	0.99	7.95	8.01	0.99	
50	-25	5.09	1.43	3.56	5.09	1.43	3.56	3.74	1.57	2.38	2.51	1.86	1.35	2.51	1.86	1.35	2.51	1.86	1.35
	-20	6.27	1.62	3.87	6.27	1.62	3.87	4.54	1.91	2.38	3.00	2.09	1.43	3.00	2.09	1.43	3.00	2.09	1.43
	-15	7.10	1.91	3.71	6.96	1.95	3.56	5.24	2.12	2.47	3.49	2.16	1.62	2.95	2.25	1.31	2.95	2.25	1.31
	-10	8.18	2.05	3.99	7.57	2.21	3.42	5.68	2.36	2.41	3.79	2.42	1.56	3.69	2.45	1.51	3.69	2.45	1.51
	-7	8.62	2.17	3.98	7.55	2.24	3.37	5.75	2.51	2.29	4.18	2.72	1.53	4.18	2.72	1.53	4.18	2.72	1.53
	-5	9.04	2.35	3.85	7.65	2.51	3.05	5.82	2.66	2.19	4.48	2.79	1.61	4.48	2.79	1.61	4.48	2.79	1.61
	-2	9.29	2.57	3.61	7.86	2.70	2.91	5.94	2.86	2.08	4.55	2.97	1.53	4.55	2.97	1.53	4.55	2.97	1.53
	0	8.99	2.61	3.45	8.03	2.76	2.91	6.12	2.92	2.10	4.62	3.00	1.54	4.62	3.00	1.54	4.62	3.00	1.54
	2	9.11	2.75	3.31	8.26	2.80	2.95	6.24	3.02	2.07	4.90	3.27	1.50	4.90	3.27	1.50	4.90	3.27	1.50
	5	9.85	3.03	3.25	8.63	3.12	2.77	6.57	3.32	1.98	5.47	3.40	1.61	5.47	3.40	1.61	5.47	3.40	1.61
	7	10.36	3.28	3.16	9.75	3.33	2.93	7.39	3.58	2.06	5.99	3.78	1.58	5.99	3.78	1.58	5.99	3.78	1.58
	10	10.48	3.55	2.95	9.45	3.68	2.57	7.09	3.91	1.81	6.10	3.97	1.53	6.10	3.97	1.53	6.10	3.97	1.53
	12	10.75	3.83	2.80	9.42	3.98	2.37	7.14	4.21	1.70	6.52	4.24	1.54	6.52	4.24	1.54	6.52	4.24	1.54
	15	10.51	4.00	2.63	9.41	4.13	2.28	7.14	4.35	1.64	6.66	4.37	1.53	6.66	4.37	1.53	6.66	4.37	1.53
	20	10.31	4.40	2.34	9.53	4.48	2.13	7.12	4.70	1.51	5.95	4.84	1.23	5.95	4.84	1.23	5.95	4.84	1.23
	25	10.41	4.91	2.12	9.38	5.04	1.86	7.13	5.34	1.33	6.59	5.38	1.22	6.59	5.38	1.22	6.59	5.38	1.22
30	10.11	5.57	1.81	9.36	5.71	1.64	7.27	5.99	1.21	7.27	5.99	1.21	7.27	5.99	1.21	7.27	5.99	1.21	
35	9.70	6.45	1.50	9.50	6.47	1.47	7.98	6.67	1.20	7.98	6.67	1.20	7.98	6.67	1.20	7.98	6.67	1.20	
55	-25	5.00	1.36	3.67	5.00	1.36	3.67	3.78	1.53	2.47	2.59	1.67	1.55	2.59	1.67	1.55	2.59	1.67	1.55
	-20	6.21	1.55	3.99	6.21	1.55	3.99	4.66	1.74	2.68	3.10	1.87	1.66	2.77	2.07	1.34	2.77	2.07	1.34
	-15	6.98	1.69	4.13	6.98	1.69	4.13	5.33	1.89	2.82	3.58	1.98	1.81	3.29	2.12	1.55	3.29	2.12	1.55
	-10	8.14	1.89	4.31	7.34	2.02	3.64	5.48	2.20	2.49	4.08	2.38	1.71	4.08	2.38	1.71	4.08	2.38	1.71
	-7	8.61	2.01	4.28	7.40	2.10	3.52	5.54	2.34	2.37	4.61	2.43	1.90	4.61	2.43	1.90	4.61	2.43	1.90
	-5	8.96	2.14	4.20	7.67	2.18	3.52	5.84	2.50	2.33	4.92	2.60	1.89	4.92	2.60	1.89	4.92	2.60	1.89
	-2	9.22	2.19	4.22	8.01	2.23	3.59	6.07	2.58	2.35	5.00	2.73	1.83	5.00	2.73	1.83	5.00	2.73	1.83
	0	8.85	2.40	3.68	8.01	2.46	3.26	6.10	2.67	2.28	5.03	2.78	1.81	5.03	2.78	1.81	5.03	2.78	1.81
	2	8.96	2.46	3.65	8.40	2.50	3.36	6.32	2.81	2.25	5.33	2.93	1.82	5.33	2.93	1.82	5.33	2.93	1.82
	5	9.68	2.86	3.39	8.62	2.92	2.95	6.53	3.12	2.09	5.96	3.12	1.91	5.96	3.12	1.91	5.96	3.12	1.91
	7	10.17	3.00	3.39	9.50	3.05	3.11	7.13	3.33	2.14	6.52	3.42	1.91	6.52	3.42	1.91	6.52	3.42	1.91
	10	10.37	3.15	3.29	9.17	3.35	2.74	7.02	3.60	1.95	6.11	3.70	1.65	6.11	3.70	1.65	6.11	3.70	1.65
	12	10.72	3.30	3.25	9.24	3.50	2.64	6.93	3.95	1.75	6.55	3.97	1.65	6.55	3.97	1.65	6.55	3.97	1.65
	15	10.48	3.53	2.97	9.24	3.79	2.44	6.92	4.04	1.71	6.71	4.06	1.65	6.71	4.06	1.65	6.71	4.06	1.65
	20	10.25	3.85	2.66	9.07	4.10	2.21	6.81	4.37	1.56	6.04	4.44	1.36	6.04	4.44	1.36	6.04	4.44	1.36
	25	10.35	4.20	2.46	9.08	4.60	1.97	6.81	4.92	1.38	6.66	4.94	1.35	6.66	4.94	1.35	6.66	4.94	1.35
30	10.04	4.87	2.06	9.09	5.16	1.76	7.35	5.47	1.34	7.35	5.47	1.34	7.35	5.47	1.34	7.35	5.47	1.34	
35	9.59	5.45	1.76	9.13	5.49	1.66	8.10	5.84	1.39	8.10	5.84	1.39	8.10	5.84	1.39	8.10	5.84	1.39	
60	-25	/	/	/	/	/	/	/	/	/	/	/	/	/	/	/	/	/	/
	-20	6.12	1.50	4.08	5.97	1.57	3.80	4.57	1.77	2.58	3.04	1.97	1.54	2.92	1.99	1.47	2.92	1.99	1.47
	-15	6.94	1.61	4.31	6.94	1.61	4.31	5.33	1.81	2.95	3.57	2.02	1.77	3.45	2.04	1.69	3.45	2.04	1.69
	-10	8.12	1.89	4.30	7.10	1.97	3.61	5.42	2.20	2.46	4.27	2.46	1.73	4.27	2.46	1.73	4.27	2.46	1.73
	-7	8.58	1.95	4.40	7.12	2.03	3.51	5.31	2.35	2.26	4.80	2.50	1.92	4.80	2.50	1.92	4.80	2.50	1.92
	-5	8.90	2.04	4.35	7.46	2.16	3.46	5.68	2.38	2.39	5.14	2.57	2.00	5.14	2.57	2.00	5.14	2.57	2.00
	-2	9.18	2.06	4.44	7.46	2.22	3.36	5.68	2.42	2.35	4.83	2.60	1.86	4.83	2.60	1.86	4.83	2.60	1.86
	0	8.73	2.27	3.85	8.01	2.32	3.45	6.10	2.53	2.42	4.82	2.73	1.77	4.82	2.73	1.77	4.82	2.73	1.77
	2	8.82	2.33	3.78	8.35	2.36	3.54	6.37	2.60	2.45	5.10	2.87	1.78	5.10	2.87	1.78	5.10	2.87	1.78
	5	9.46	2.56	3.69	8.65	2.65	3.27	6.52	2.90	2.24	5.99	3.05	1.96	5.99	3.05	1.96	5.99	3.05	1.96
	7	9.90	2.75	3.60	9.27	2.82	3.28	6.99	3.13	2.23	6.24	3.29	1.89	6.24	3.29	1.89	6.24	3.29	1.89
	10	10.18	2.94	3.46	9.28	3.01	3.08	7.01	3.45	2.03	6.10	3.61	1.69	6.10	3.61	1.69	6.10	3.61	1.69
	12	10.41	3.10	3.36	9.23	3.29	2.81	6.90	3.78	1.83	6.51	3.82	1.70	6.51	3.82	1.70	6.51	3.82	1.70
	15	10.17	3.21	3.16	9.22	3.40	2.71	6.68	3.98	1.68	6.68	3.98	1.68	6.68	3.98	1.68	6.68	3.98	1.68
	20	9.93	3.45	2.87	9.31	3.67	2.54	6.85	4.18	1.64	5.99	4.36	1.37	5.99	4.36	1.37	5.99	4.36	1.37
	25	9.99	3.76	2.65	9.10	4.04	2.25	6.89	4.58	1.50	6.3								

LWT	DB	Maximum			100% (Normal)			75%			50%			25%			Minimum		
		HC	COP	PI	HC	COP	PI	HC	COP	PI	HC	COP	PI	HC	COP	PI	HC	COP	PI
65	-25	/	/	/	/	/	/	/	/	/	/	/	/	/	/	/	/	/	/
	-20	6.10	1.47	4.16	6.10	1.47	4.16	4.62	1.50	3.08	3.18	1.60	1.99	2.82	1.62	1.74	2.82	1.62	1.74
	-15	6.81	1.57	4.34	6.81	1.57	4.34	5.10	1.63	3.13	3.45	1.87	1.84	3.45	1.87	1.84	3.45	1.87	1.84
	-10	8.01	1.78	4.49	7.40	1.84	4.03	5.60	1.87	2.99	4.10	2.12	1.93	4.10	2.12	1.93	4.10	2.12	1.93
	-7	8.56	1.87	4.58	7.39	1.99	3.71	5.62	2.09	2.69	4.63	2.17	2.13	4.63	2.17	2.13	4.63	2.17	2.13
	-5	8.82	1.94	4.55	7.60	2.05	3.72	5.78	2.12	2.73	4.98	2.29	2.18	4.98	2.29	2.18	4.98	2.29	2.18
	-2	9.14	2.01	4.55	7.87	2.10	3.75	6.00	2.16	2.77	4.64	2.41	1.93	4.64	2.41	1.93	4.64	2.41	1.93
	0	8.58	2.09	4.10	8.15	2.18	3.74	6.21	2.20	2.82	4.58	2.51	1.82	4.58	2.51	1.82	4.58	2.51	1.82
	2	8.64	2.19	3.94	8.28	2.24	3.69	6.32	2.30	2.74	4.86	2.48	1.96	4.86	2.48	1.96	4.86	2.48	1.96
	5	9.21	2.37	3.89	8.66	2.41	3.60	6.53	2.53	2.58	5.44	2.71	2.01	5.44	2.71	2.01	5.44	2.71	2.01
	7	9.61	2.50	3.85	9.26	2.55	3.64	6.98	2.69	2.59	5.95	2.89	2.06	5.95	2.89	2.06	5.95	2.89	2.06
	10	9.84	2.72	3.62	9.20	2.77	3.32	6.98	2.91	2.40	5.75	3.14	1.83	5.75	3.14	1.83	5.75	3.14	1.83
	12	10.05	2.88	3.49	9.28	2.94	3.16	7.00	3.08	2.27	6.16	3.20	1.92	6.16	3.20	1.92	6.16	3.20	1.92
	15	9.81	2.97	3.31	9.30	3.03	3.07	6.84	3.27	2.09	6.31	3.30	1.91	6.31	3.30	1.91	6.31	3.30	1.91
	20	9.56	3.21	2.98	9.30	3.26	2.86	6.91	3.45	2.00	5.99	3.67	1.47	5.99	3.67	1.47	5.99	3.67	1.47
	25	9.60	3.50	2.74	9.22	3.54	2.61	7.00	3.74	1.87	5.99	3.96	1.51	5.99	3.96	1.51	5.99	3.96	1.51
30	9.18	3.90	2.36	9.18	3.90	2.36	6.61	4.01	1.65	6.61	4.01	1.65	6.61	4.01	1.65	6.61	4.01	1.65	
35	/	/	/	/	/	/	/	/	/	/	/	/	/	/	/	/	/	/	
70	-25	/	/	/	/	/	/	/	/	/	/	/	/	/	/	/	/	/	/
	-20	/	/	/	/	/	/	/	/	/	/	/	/	/	/	/	/	/	/
	-15	6.86	1.45	4.72	6.86	1.45	4.72	5.32	1.61	3.30	3.19	1.93	1.66	3.19	1.93	1.66	3.19	1.93	1.66
	-10	7.86	1.59	4.94	7.11	1.75	4.06	5.43	1.91	2.84	3.99	2.12	1.88	3.99	2.12	1.88	3.99	2.12	1.88
	-7	8.21	1.69	4.85	7.01	1.87	3.76	5.36	1.99	2.69	4.55	2.13	2.13	4.55	2.13	2.13	4.55	2.13	2.13
	-5	8.43	1.78	4.73	7.20	1.96	3.67	5.46	2.10	2.59	4.87	2.25	2.17	4.87	2.25	2.17	4.87	2.25	2.17
	-2	8.78	1.82	4.83	7.39	1.99	3.71	5.61	2.13	2.63	4.46	2.32	1.92	4.46	2.32	1.92	4.46	2.32	1.92
	0	8.37	1.91	4.38	7.58	2.03	3.74	5.69	2.19	2.60	4.50	2.38	1.89	4.50	2.38	1.89	4.50	2.38	1.89
	2	8.40	2.03	4.13	8.40	2.03	4.13	6.38	2.23	2.86	4.59	2.42	1.89	4.59	2.42	1.89	4.59	2.42	1.89
	5	8.90	2.18	4.08	8.90	2.18	4.08	6.53	2.37	2.76	5.14	2.58	1.99	5.14	2.58	1.99	5.14	2.58	1.99
	7	9.23	2.31	4.00	9.23	2.31	4.00	7.03	2.60	2.70	5.62	2.82	2.00	5.62	2.82	2.00	5.62	2.82	2.00
	10	9.43	2.45	3.85	9.43	2.45	3.85	6.94	2.78	2.49	5.36	3.02	1.77	5.36	3.02	1.77	5.36	3.02	1.77
	12	9.66	2.61	3.70	9.66	2.61	3.70	6.93	2.92	2.37	5.75	3.11	1.85	5.75	3.11	1.85	5.75	3.11	1.85
	15	9.40	2.68	3.51	9.40	2.68	3.51	6.89	2.98	2.31	5.90	3.14	1.88	5.90	3.14	1.88	5.90	3.14	1.88
	20	9.21	2.87	3.21	9.21	2.87	3.21	6.92	3.17	2.18	5.86	3.34	1.75	5.86	3.34	1.75	5.86	3.34	1.75
	25	9.18	3.04	3.02	9.18	3.04	3.02	6.94	3.14	2.21	5.61	3.53	1.59	5.61	3.53	1.59	5.61	3.53	1.59
30	/	/	/	/	/	/	/	/	/	/	/	/	/	/	/	/	/	/	/
35	/	/	/	/	/	/	/	/	/	/	/	/	/	/	/	/	/	/	/
75	-25	/	/	/	/	/	/	/	/	/	/	/	/	/	/	/	/	/	/
	-20	/	/	/	/	/	/	/	/	/	/	/	/	/	/	/	/	/	/
	-15	/	/	/	/	/	/	/	/	/	/	/	/	/	/	/	/	/	/
	-10	7.77	1.51	5.16	7.14	1.58	4.51	5.40	1.61	3.36	3.92	1.83	2.14	3.92	1.83	2.14	3.92	1.83	2.14
	-7	8.10	1.62	5.00	7.12	1.73	4.12	5.35	1.76	3.04	4.12	1.99	2.07	4.12	1.99	2.07	4.12	1.99	2.07
	-5	8.31	1.68	4.94	7.26	1.78	4.07	5.47	1.82	3.01	4.23	2.04	2.07	4.23	2.04	2.07	4.23	2.04	2.07
	-2	8.63	1.76	4.89	7.81	1.82	4.28	5.89	1.85	3.18	4.31	2.08	2.07	4.31	2.08	2.07	4.31	2.08	2.07
	0	8.01	1.84	4.36	8.01	1.84	4.36	5.99	1.87	3.21	4.40	2.11	2.09	4.40	2.11	2.09	4.40	2.11	2.09
	2	8.14	1.89	4.30	8.14	1.89	4.30	6.19	1.95	3.18	4.51	2.16	2.08	4.51	2.16	2.08	4.51	2.16	2.08
	5	8.60	1.95	4.42	8.60	1.95	4.42	6.46	2.14	3.02	4.80	2.42	1.99	4.80	2.42	1.99	4.80	2.42	1.99
	7	8.85	2.05	4.32	8.85	2.05	4.32	6.55	2.31	2.84	5.26	2.57	2.05	5.26	2.57	2.05	5.26	2.57	2.05
	10	8.91	2.23	3.99	8.91	2.23	3.99	6.81	2.56	2.66	4.87	2.66	1.83	4.87	2.66	1.83	4.87	2.66	1.83
	12	9.12	2.35	3.88	9.12	2.35	3.88	6.97	2.68	2.60	5.22	2.78	1.88	5.22	2.78	1.88	5.22	2.78	1.88
	15	8.94	2.43	3.68	8.94	2.43	3.68	6.81	2.74	2.49	5.37	2.84	1.89	5.37	2.84	1.89	5.37	2.84	1.89
	20	8.89	2.65	3.36	8.89	2.65	3.36	6.78	2.80	2.42	4.59	3.08	1.49	4.59	3.08	1.49	4.59	3.08	1.49
	25	/	/	/	/	/	/	/	/	/	/	/	/	/	/	/	/	/	/
30	/	/	/	/	/	/	/	/	/	/	/	/	/	/	/	/	/	/	/
35	/	/	/	/	/	/	/	/	/	/	/	/	/	/	/	/	/	/	/

Abbreviations:

LWT: Leaving water temperature (°C)

DB: Dry-bulb temperature for Outdoor air temperature (°C)

HC: Total heating capacity (kW)

PI: Power input (kW)

16 kW heating capacity

LWT	DB	Maximum			100% (Normal)			75%			50%			25%			Minimum		
		HC	COP	PI	HC	COP	PI	HC	COP	PI	HC	COP	PI	HC	COP	PI	HC	COP	PI
25	-25	9.50	1.99	4.77	9.50	1.99	4.77	9.50	1.99	4.77	6.47	2.26	2.87	2.98	2.56	1.17	2.98	2.56	1.17
	-20	11.26	2.37	4.75	11.26	2.37	4.75	9.73	2.54	3.83	6.53	2.72	2.40	3.77	3.11	1.21	3.77	3.11	1.21
	-15	12.59	2.63	4.78	12.59	2.63	4.78	9.45	3.07	3.08	6.18	3.26	1.90	4.37	3.77	1.16	4.37	3.77	1.16
	-10	13.33	2.76	4.84	12.68	2.84	4.47	9.54	3.24	2.95	6.32	3.54	1.78	4.69	3.99	1.18	4.69	3.99	1.18
	-7	13.66	2.87	4.75	12.66	3.06	4.14	9.31	3.74	2.49	6.35	4.10	1.55	5.41	4.44	1.22	5.41	4.44	1.22
	-5	14.12	3.11	4.53	12.76	3.30	3.87	9.48	3.75	2.53	6.34	4.23	1.50	5.60	4.55	1.23	5.60	4.55	1.23
	-2	14.53	3.42	4.25	12.62	3.68	3.43	9.63	4.20	2.29	6.36	4.71	1.35	4.86	5.22	0.93	4.86	5.22	0.93
	0	14.83	3.64	4.08	12.56	3.96	3.17	9.45	4.59	2.06	6.27	5.10	1.23	5.02	5.42	0.93	5.02	5.42	0.93
	2	15.03	3.84	3.91	12.65	4.24	2.98	9.46	4.93	1.92	6.45	5.41	1.19	5.38	5.80	0.93	5.38	5.80	0.93
	5	16.61	4.48	3.71	14.00	4.99	2.80	10.59	5.95	1.78	7.06	6.67	1.06	5.85	7.00	0.84	5.85	7.00	0.84
	7	18.67	5.02	3.72	14.95	5.68	2.63	11.19	6.44	1.74	7.50	7.28	1.03	6.24	7.44	0.84	6.24	7.44	0.84
	10	20.15	5.81	3.47	15.07	7.12	2.12	11.31	7.86	1.44	7.58	8.85	0.86	7.25	8.95	0.81	7.25	8.95	0.81
	12	20.80	6.32	3.29	15.03	7.78	1.93	11.26	8.70	1.29	7.71	9.79	0.79	7.71	9.79	0.79	7.71	9.79	0.79
	15	19.18	6.60	2.91	15.08	8.04	1.88	11.23	9.16	1.23	7.78	10.26	0.76	7.78	10.26	0.76	7.78	10.26	0.76
	20	16.84	7.51	2.24	15.04	8.19	1.84	11.32	9.88	1.15	7.46	11.00	0.68	6.62	11.24	0.59	6.62	11.24	0.59
	25	17.20	8.27	2.08	14.89	9.12	1.63	11.38	10.81	1.05	7.48	11.73	0.64	7.40	11.79	0.63	7.40	11.79	0.63
30	/	/	/	/	/	/	/	/	/	/	/	/	/	/	/	/	/	/	/
35	/	/	/	/	/	/	/	/	/	/	/	/	/	/	/	/	/	/	/
30	-25	9.03	1.82	4.96	9.03	1.82	4.96	9.03	1.82	4.96	6.06	1.99	3.05	2.78	2.25	1.24	2.78	2.25	1.24
	-20	10.78	2.07	5.21	10.78	2.07	5.21	9.38	2.17	4.32	6.19	2.40	2.58	3.56	2.76	1.29	3.56	2.76	1.29
	-15	12.13	2.41	5.03	12.13	2.41	5.03	9.32	2.72	3.43	6.13	2.85	2.15	4.19	3.36	1.25	4.19	3.36	1.25
	-10	12.81	2.50	5.12	12.71	2.52	5.05	9.40	2.86	3.29	6.24	3.10	2.01	4.58	3.58	1.28	4.58	3.58	1.28
	-7	13.43	2.67	5.02	12.64	2.80	4.51	9.31	3.33	2.80	6.37	3.72	1.71	5.39	4.03	1.34	5.39	4.03	1.34
	-5	13.60	2.82	4.82	12.65	2.93	4.32	9.42	3.30	2.85	6.20	3.66	1.70	5.38	4.10	1.31	5.38	4.10	1.31
	-2	14.02	3.10	4.53	12.40	3.29	3.77	9.47	3.68	2.57	6.47	3.99	1.62	4.66	4.56	1.02	4.66	4.56	1.02
	0	14.31	3.29	4.35	12.54	3.51	3.58	9.45	3.98	2.37	6.18	4.35	1.42	4.74	4.63	1.02	4.74	4.63	1.02
	2	14.50	3.47	4.18	12.64	3.72	3.40	9.50	4.26	2.23	6.21	4.61	1.35	5.16	5.02	1.03	5.16	5.02	1.03
	5	16.01	4.03	3.97	14.18	4.33	3.28	10.37	5.16	2.01	7.04	5.64	1.25	5.54	5.92	0.93	5.54	5.92	0.93
	7	17.89	4.49	3.98	15.23	4.86	3.13	11.25	5.50	2.04	7.52	6.08	1.24	5.98	6.33	0.94	5.98	6.33	0.94
	10	19.22	5.15	3.73	15.19	5.93	2.56	11.17	6.62	1.69	7.43	7.46	1.00	6.91	7.52	0.92	6.91	7.52	0.92
	12	19.84	5.59	3.55	15.03	6.65	2.26	11.20	7.29	1.54	7.72	8.01	0.96	7.32	8.10	0.90	7.32	8.10	0.90
	15	18.32	5.80	3.16	15.03	6.80	2.21	11.43	7.56	1.51	7.59	8.73	0.87	7.59	8.73	0.87	7.59	8.73	0.87
	20	16.17	6.55	2.47	15.00	7.26	2.07	11.25	8.36	1.35	7.50	9.22	0.81	6.37	9.36	0.68	6.37	9.36	0.68
	25	16.57	7.17	2.31	15.04	7.58	1.98	11.19	8.99	1.24	7.46	9.53	0.78	7.11	9.62	0.74	7.11	9.62	0.74
30	15.63	8.79	1.78	14.89	9.34	1.59	11.34	10.62	1.07	7.86	11.26	0.70	7.78	11.27	0.69	7.78	11.27	0.69	
35	/	/	/	/	/	/	/	/	/	/	/	/	/	/	/	/	/	/	/
35	-25	8.83	1.74	5.08	8.83	1.74	5.08	8.83	1.76	5.02	6.21	1.85	3.36	2.68	2.02	1.33	2.68	2.02	1.33
	-20	10.56	1.96	5.39	10.56	1.96	5.39	9.30	2.07	4.50	6.25	2.20	2.85	3.47	2.50	1.39	3.47	2.50	1.39
	-15	11.96	2.27	5.28	11.96	2.23	5.37	9.25	2.50	3.70	6.35	2.62	2.42	4.16	2.97	1.40	4.16	2.97	1.40
	-10	12.55	2.33	5.39	12.55	2.33	5.39	9.39	2.56	3.66	6.32	2.88	2.19	4.50	3.28	1.37	4.50	3.28	1.37
	-7	13.18	2.48	5.31	12.70	2.50	5.08	9.41	2.90	3.24	6.44	3.35	1.92	5.25	3.58	1.47	5.25	3.58	1.47
	-5	13.38	2.62	5.10	12.55	2.71	4.64	9.44	3.01	3.14	6.27	3.28	1.91	5.08	3.62	1.40	5.08	3.62	1.40
	-2	13.78	2.87	4.81	12.47	3.01	4.14	9.51	3.33	2.86	6.33	3.60	1.76	4.57	4.12	1.11	4.57	4.12	1.11
	0	14.05	3.03	4.64	12.80	3.17	4.03	9.64	3.56	2.71	6.30	3.87	1.63	4.73	4.33	1.09	4.73	4.33	1.09
	2	14.27	3.20	4.46	12.80	3.20	4.00	9.72	3.80	2.55	6.35	4.09	1.55	5.07	4.50	1.13	5.07	4.50	1.13
	5	15.77	3.72	4.24	14.20	3.92	3.63	10.49	4.57	2.30	7.02	4.96	1.42	5.36	5.18	1.03	5.36	5.18	1.03
	7	17.57	4.13	4.25	15.00	4.40	3.41	11.17	4.89	2.28	7.50	5.31	1.41	5.87	5.61	1.05	5.87	5.61	1.05
	10	18.31	4.58	4.00	14.94	5.04	2.97	11.24	5.51	2.04	7.49	6.09	1.23	6.42	6.22	1.03	6.42	6.22	1.03
	12	18.87	4.93	3.82	15.01	5.52	2.72	11.29	5.99	1.88	8.35	6.45	1.29	6.82	6.71	1.02	6.82	6.71	1.02
	15	17.44	5.10	3.42	15.03	5.61	2.68	11.37	6.23	1.83	7.44	6.98	1.07	7.09	7.20	0.99	7.09	7.20	0.99
	20	15.44	5.70	2.71	15.00	6.09	2.46	11.25	6.92	1.62	7.50	7.48	1.00	5.97	7.99	0.75	5.97	7.99	0.75
	25	15.82	6.18	2.56	14.97	6.45	2.32	11.11	7.48	1.49	7.51	8.30	0.90	6.68	8.47	0.79	6.68	8.47	0.79
30	14.95	7.47	2.00	14.95	7.47	2.00	11.30	8.60	1.31	7.66	8.91	0.86	7.30	9.00	0.81	7.30	9.00	0.81	
35	13.82	9.45	1.46	13.82	9.45	1.46	11.09	10.10	1.10	8.07	10.43	0.77	7.97	10.45	0.76	7.97	10.45	0.76	
40	-25	8.64	1.56	5.53	8.64	1.56	5.53	8.64	1.56	5.53	6.26	1.74	3.60	2.74	1.89	1.45	2.74	1.89	1.45
	-20	10.39	1.83	5.68	10.39	1.83	5.68	9.32	1.90	4.91	6.33	2.09	3.03	3.57	2.31	1.55	3.57	2.31	1.55
	-15	11.78	2.05	5.74	11.78	2.05	5.74	9.30	2.24	4.14	6.47	2.41	2.69	3.99	2.59	1.54	3.99	2.59	1.54
	-10	12.31	2.08	5.92	12.31	2.08	5.92	9.38	2.34	4.00	6.28	2.59	2.43	4.63	2.98	1.55	4.63	2.98	1.55
	-7	12.95	2.31	5.61	12.59	2.36	5.33	9.53	2.79	3.42	6.41	3.11	2.06	5.36	3.39	1.58	5.36	3.39	1.58
	-5	13.14	2.40	5.46	12.56	2.49	5.05	9.46	2.75	3.43	6.33	2.97	2.13	5.43	3.45	1.57	5.43	3.45	1.57
	-2	13.54	2.65	5.11	12.64	2.74	4.61	9.42	3.03	3.11	6.28	3.24	1.94	5.34	3.62	1.47	5.34	3.62	1.47
	0	13.83	2.81	4.93	12.85	2.90	4.43	9.68	3.21	3.02	6.38	3.44	1.85	5.63	3.78	1.49	5.63	3.78	1.49
	2	14.02	2.95	4.75	13.14	3.05	4.31	9.77	3.41	2.86	6.45	3.63	1.78	5.90	3.92	1.51	5.90	3.92	1.51
	5	15.49	3.42	4.53	14.20	3.55	4.00	10.58	4.10	2.58	7.19	4.28	1.68	6.70	4.38	1.53	6.70	4.38	1.53
	7	17.21	3.78	4.55	15.12	3.97	3.81	11.26	4.32	2.61	7.38	4.82	1.53	7.38	4.82	1.53	7.38	4.82	1.53
	10	17.92	4.18	4.29	14.99	4.48	3.34	11.16	4.85	2.30	7.64	5.36	1.43	7.64	5.36	1.43	7.64	5.36	1.43
	12	18.46	4.48	4.12	15.10	4.89	3.09	11.21	5.28	2.12	7.98	5.62	1.42	7.98	5.62	1.42	7.98	5.62	1.42
	15	17.11	4.63	3.69	15.11	4.95	3.05	11.31	5.49	2.06	8.44	6.08	1.39	8.44	6.08	1.39	8.44	6.08	1.39
	20	15.24	5.11	2.98	15.00	5.35	2.80	11.25	6.04	1.86	7.50	6.36	1.18	6.69	6.48	1.03	6.69	6.48	1.03
	25	15.60	5.54	2.82															

LWT	DB	Maximum			100% (Normal)			75%			50%			25%			Minimum		
		HC	COP	PI	HC	COP	PI	HC	COP	PI	HC	COP	PI	HC	COP	PI	HC	COP	PI
45	-25	8.45	1.48	5.70	8.45	1.48	5.70	8.45	1.48	5.70	6.35	1.59	3.99	3.16	1.77	1.79	3.16	1.77	1.79
	-20	10.59	1.78	5.94	10.59	1.70	6.22	9.46	1.78	5.30	6.33	1.99	3.18	4.07	2.14	1.90	4.07	2.14	1.90
	-15	11.60	1.90	6.11	11.60	1.90	6.11	9.34	2.12	4.40	6.40	2.29	2.80	4.52	2.37	1.90	4.52	2.37	1.90
	-10	12.08	2.04	5.92	12.08	2.04	5.92	9.35	2.23	4.19	6.11	2.51	2.44	5.19	2.69	1.93	5.19	2.69	1.93
	-7	12.50	2.25	5.56	12.50	2.25	5.56	9.58	2.53	3.78	6.05	2.91	2.08	5.86	2.98	1.97	5.86	2.98	1.97
	-5	12.89	2.25	5.72	12.56	2.29	5.49	9.46	2.53	3.75	6.02	3.01	2.00	6.02	3.01	2.00	6.02	3.01	2.00
	-2	13.28	2.45	5.43	12.66	2.51	5.05	9.43	2.75	3.42	6.29	3.18	1.98	6.29	3.18	1.98	6.29	3.18	1.98
	0	13.57	2.59	5.24	13.17	2.63	5.01	9.71	2.92	3.33	6.68	3.31	2.02	6.68	3.31	2.02	6.68	3.31	2.02
	2	13.77	2.73	5.04	13.10	2.75	4.76	9.79	3.07	3.18	7.00	3.42	2.04	7.00	3.42	2.04	7.00	3.42	2.04
	5	15.19	3.15	4.83	14.18	3.24	4.38	10.72	3.68	2.92	7.19	3.85	1.87	7.19	3.85	1.87	7.19	3.85	1.87
	7	16.85	3.47	4.85	15.00	3.35	4.48	11.43	3.90	2.93	7.98	4.26	1.88	7.98	4.26	1.88	7.98	4.26	1.88
	10	17.50	3.81	4.60	15.01	4.02	3.73	11.24	4.35	2.59	8.30	4.67	1.78	8.30	4.67	1.78	8.30	4.67	1.78
	12	18.04	4.07	4.43	15.12	4.24	3.57	11.32	4.66	2.43	8.60	4.84	1.78	8.60	4.84	1.78	8.60	4.84	1.78
	15	16.72	4.20	3.98	15.14	4.38	3.46	11.21	4.83	2.32	9.18	5.26	1.74	9.18	5.26	1.74	9.18	5.26	1.74
	20	15.01	4.62	3.25	15.01	4.62	3.25	11.25	5.33	2.11	7.42	5.61	1.32	7.42	5.61	1.32	7.42	5.61	1.32
	25	15.36	4.99	3.08	14.96	5.07	2.95	11.17	5.75	1.94	8.34	5.96	1.40	8.34	5.96	1.40	8.34	5.96	1.40
30	14.48	5.86	2.47	14.48	5.86	2.47	11.18	6.50	1.72	9.14	6.65	1.38	9.14	6.65	1.38	9.14	6.65	1.38	
35	13.38	7.10	1.88	13.38	7.10	1.88	11.35	7.37	1.54	10.01	7.48	1.34	10.01	7.48	1.34	10.01	7.48	1.34	
50	-25	8.26	1.38	6.01	8.26	1.38	6.01	8.26	1.38	6.01	6.35	1.48	4.28	3.36	1.63	2.06	3.36	1.63	2.06
	-20	9.99	1.63	6.14	9.99	1.63	6.14	9.48	1.66	5.72	6.32	1.85	3.42	4.32	1.98	2.18	4.32	1.98	2.18
	-15	11.60	1.77	6.56	11.60	1.77	6.56	9.41	1.93	4.88	6.30	2.05	3.07	4.79	2.17	2.21	4.79	2.17	2.21
	-10	11.70	1.90	6.15	11.70	1.90	6.15	9.35	2.03	4.60	6.11	2.16	2.83	5.42	2.44	2.22	5.42	2.44	2.22
	-7	12.23	2.05	5.96	12.23	2.05	5.96	9.45	2.24	4.22	6.43	2.60	2.47	6.11	2.66	2.30	6.11	2.66	2.30
	-5	12.28	2.11	5.83	12.28	2.11	5.83	9.32	2.31	4.03	6.31	2.71	2.33	6.31	2.71	2.33	6.31	2.71	2.33
	-2	13.02	2.26	5.75	12.78	2.29	5.59	9.43	2.52	3.75	6.85	2.83	2.42	6.85	2.83	2.42	6.85	2.83	2.42
	0	13.28	2.38	5.58	13.15	2.39	5.50	9.70	2.65	3.67	7.23	2.96	2.44	7.23	2.96	2.44	7.23	2.96	2.44
	2	13.49	2.51	5.37	13.05	2.55	5.13	9.79	2.78	3.52	7.58	3.08	2.46	7.58	3.08	2.46	7.58	3.08	2.46
	5	14.87	2.89	5.14	14.13	2.95	4.79	10.74	3.31	3.25	8.38	3.57	2.35	8.38	3.57	2.35	8.38	3.57	2.35
	7	16.42	3.18	5.17	15.06	3.25	4.64	11.26	3.50	3.21	8.95	3.78	2.37	8.95	3.78	2.37	8.95	3.78	2.37
	10	17.06	3.47	4.92	15.16	3.59	4.22	11.28	3.87	2.92	8.90	4.12	2.16	8.90	4.12	2.16	8.90	4.12	2.16
	12	17.55	3.69	4.76	15.10	3.87	3.90	11.17	4.13	2.70	9.38	4.32	2.17	9.38	4.32	2.17	9.38	4.32	2.17
	15	16.29	3.80	4.29	15.14	3.92	3.87	11.28	4.24	2.66	9.85	4.59	2.14	9.85	4.59	2.14	9.85	4.59	2.14
	20	14.77	4.13	3.57	14.77	4.13	3.57	11.12	4.49	2.48	7.74	4.89	1.58	7.74	4.89	1.58	7.74	4.89	1.58
	25	15.09	4.39	3.43	14.89	4.43	3.36	11.17	4.97	2.25	8.61	5.19	1.66	8.61	5.19	1.66	8.61	5.19	1.66
30	14.19	5.20	2.73	14.19	5.20	2.73	11.19	5.69	1.97	9.57	5.84	1.64	9.57	5.84	1.64	9.57	5.84	1.64	
35	13.09	6.23	2.10	13.09	6.23	2.10	11.07	6.35	1.74	10.34	6.41	1.61	10.34	6.41	1.61	10.34	6.41	1.61	
55	-25	8.18	1.30	6.30	8.18	1.30	6.30	8.18	1.30	6.30	6.36	1.44	4.42	3.71	1.53	2.43	3.71	1.53	2.43
	-20	9.82	1.56	6.28	9.82	1.56	6.28	9.50	1.58	6.00	6.32	1.76	3.58	4.73	1.85	2.55	4.73	1.85	2.55
	-15	11.19	1.79	6.26	11.19	1.79	6.26	9.60	1.89	5.07	6.29	2.02	3.11	5.39	2.06	2.62	5.39	2.06	2.62
	-10	11.30	1.90	5.95	11.30	1.90	5.95	9.43	2.02	4.67	6.20	2.24	2.77	6.01	2.28	2.64	6.01	2.28	2.64
	-7	12.40	2.05	6.05	12.40	2.05	6.05	9.46	2.16	4.38	7.20	2.26	3.18	6.53	2.32	2.82	6.53	2.32	2.82
	-5	11.85	2.09	5.68	11.85	2.09	5.68	9.33	2.18	4.28	6.80	2.40	2.83	6.80	2.40	2.83	6.80	2.40	2.83
	-2	12.28	2.18	5.64	12.28	2.18	5.64	9.53	2.33	4.08	6.91	2.58	2.68	6.91	2.58	2.68	6.91	2.58	2.68
	0	12.91	2.26	5.70	12.91	2.26	5.70	9.81	2.45	4.01	7.28	2.69	2.71	7.28	2.69	2.71	7.28	2.69	2.71
	2	13.10	2.45	5.35	13.10	2.45	5.35	9.92	2.57	3.85	7.64	2.80	2.73	7.64	2.80	2.73	7.64	2.80	2.73
	5	14.74	2.66	5.54	14.27	2.75	5.19	10.82	3.05	3.55	9.12	3.21	2.84	9.12	3.21	2.84	9.12	3.21	2.84
	7	16.00	2.81	5.70	15.00	2.85	5.26	11.22	3.17	3.54	9.75	3.39	2.88	9.75	3.39	2.88	9.75	3.39	2.88
	10	16.89	3.14	5.38	14.99	3.34	4.49	11.19	3.52	3.18	9.05	3.70	2.44	9.05	3.70	2.44	9.05	3.70	2.44
	12	17.36	3.38	5.13	15.00	3.56	4.22	11.20	3.78	2.97	9.59	3.90	2.46	9.59	3.90	2.46	9.59	3.90	2.46
	15	16.14	3.53	4.58	14.95	3.61	4.14	11.29	3.85	2.93	10.06	4.14	2.43	10.06	4.14	2.43	10.06	4.14	2.43
	20	14.72	3.79	3.88	14.72	3.79	3.88	11.05	4.09	2.70	7.98	4.46	1.79	7.98	4.46	1.79	7.98	4.46	1.79
	25	15.00	4.14	3.63	15.00	4.14	3.63	11.31	4.62	2.45	9.12	4.77	1.91	9.12	4.77	1.91	9.12	4.77	1.91
30	14.09	4.75	2.97	14.09	4.75	2.97	11.10	5.06	2.19	9.92	5.19	1.91	9.92	5.19	1.91	9.92	5.19	1.91	
35	12.99	5.50	2.36	12.99	5.50	2.36	11.27	5.60	2.01	10.78	5.63	1.91	10.78	5.63	1.89	10.78	5.63	1.89	
60	-25	/	/	/	/	/	/	/	/	/	/	/	/	/	/	/	/	/	/
	-20	9.37	1.45	6.45	9.37	1.45	6.45	9.37	1.45	6.45	6.26	1.62	3.87	4.92	1.68	2.92	4.92	1.68	2.92
	-15	10.45	1.67	6.24	10.45	1.67	6.24	9.37	1.73	5.42	6.16	1.85	3.33	5.70	1.88	3.03	5.70	1.88	3.03
	-10	10.85	1.75	6.20	10.85	1.79	6.07	9.49	1.87	5.08	6.39	2.12	3.01	6.39	2.12	3.01	6.39	2.12	3.01
	-7	11.65	1.84	6.32	11.65	1.88	6.19	9.49	1.96	4.85	7.54	2.17	3.47	7.54	2.17	3.47	7.54	2.17	3.47
	-5	11.39	1.87	6.10	11.39	1.91	5.98	9.32	2.02	4.61	7.08	2.25	3.15	7.08	2.25	3.15	7.08	2.25	3.15
	-2	11.54	1.97	5.86	11.54	2.01	5.74	9.46	2.08	4.56	7.12	2.31	3.08	7.12	2.31	3.08	7.12	2.31	3.08
	0	11.91	2.04	5.83	11.91	2.08	5.72	9.74	2.17	4.48	7.52	2.41	3.12	7.52	2.41	3.12	7.52	2.41	3.12
	2	12.18	2.14	5.70	12.18	2.18	5.59	9.85	2.27	4.33	7.89	2.51	3.15	7.89	2.51	3.15	7.89	2.51	3.15
	5	14.19	2.49	5.70	14.19	2.49	5.70	10.75	2.67	4.03	8.91	2.87	3.10	8.91	2.87	3.10	8.91	2.87	3.10
	7	15.59	2.63	5.93	15.10	2.68	5.64	11.10	2.88	3.85	9.55	3.04	3.14	9.55	3.04	3.14	9.55	3.04	3.14
	10	16.34	2.82	5.79	15.00	2.94	5.11	11.25	3.13	3.59	9.12	3.29	2.77	9.12	3.29	2.77	9.12	3.29	2.77
	12	16.78	3.05	5.50	14.97	3.17	4.72	11.17	3.35	3.34	9.66	3.45	2.80	9.66	3.45	2.80	9.66	3.45	2.80
	15	15.61	3.14	4.97	15.04	3.20	4.69	11.26	3.43	3.29	10.19	3.68	2.77	10.19	3.68	2.77	10.19	3.68	2.77
	20	14.03	3.35	4.18	14.03	3.35	4.18	11.18	3.60	3.10	8.16	3.96	2.06	8.1					

LWT	DB	Maximum			100% (Normal)			75%			50%			25%			Minimum		
		HC	COP	PI	HC	COP	PI	HC	COP	PI	HC	COP	PI	HC	COP	PI	HC	COP	PI
65	-25	/	/	/	/	/	/	/	/	/	/	/	/	/	/	/	/	/	/
	-20	8.66	1.39	6.21	8.66	1.39	6.21	8.66	1.39	6.21	6.29	1.41	4.47	4.66	1.51	3.08	4.66	1.51	3.08
	-15	9.67	1.52	6.36	9.67	1.52	6.36	9.20	1.55	5.93	6.22	1.73	3.60	5.64	1.79	3.15	5.64	1.79	3.15
	-10	10.37	1.72	6.02	10.37	1.72	6.02	9.44	1.76	5.37	6.46	2.01	3.22	6.46	2.01	3.22	6.46	2.01	3.22
	-7	10.85	1.79	6.05	10.85	1.79	6.05	9.40	1.82	5.16	6.68	2.02	3.31	6.68	2.02	3.31	6.68	2.02	3.31
	-5	10.83	1.81	5.98	10.83	1.81	5.98	9.43	1.90	4.96	6.94	2.06	3.37	6.94	2.06	3.37	6.94	2.06	3.37
	-2	10.89	1.90	5.72	10.89	1.90	5.72	9.52	1.94	4.92	6.90	2.10	3.29	6.90	2.10	3.29	6.90	2.10	3.29
	0	11.29	1.94	5.83	11.29	1.94	5.83	9.67	2.00	4.84	7.22	2.16	3.34	7.22	2.16	3.34	7.22	2.16	3.34
	2	11.32	2.01	5.63	11.32	2.01	5.63	9.85	2.08	4.74	7.57	2.24	3.38	7.57	2.24	3.38	7.57	2.24	3.38
	5	13.21	2.36	5.60	13.21	2.36	5.60	10.62	2.42	4.38	8.52	2.56	3.32	8.52	2.56	3.32	8.52	2.56	3.32
	7	14.71	2.43	6.06	14.71	2.43	6.06	11.39	2.55	4.46	9.06	2.79	3.25	9.06	2.79	3.25	9.06	2.79	3.25
	10	15.00	2.61	5.75	15.00	2.61	5.75	11.20	2.70	4.14	8.74	2.92	2.99	8.74	2.92	2.99	8.74	2.92	2.99
	12	15.35	2.72	5.65	15.17	2.74	5.53	11.26	2.90	3.88	9.28	3.07	3.03	9.28	3.07	3.03	9.28	3.07	3.03
	15	15.04	2.81	5.36	15.04	2.81	5.36	11.17	3.03	3.69	9.84	3.28	3.00	9.84	3.28	3.00	9.84	3.28	3.00
	20	13.09	3.06	4.27	13.09	3.06	4.27	11.25	3.20	3.52	7.87	3.53	2.23	7.87	3.53	2.23	7.87	3.53	2.23
	25	14.27	3.31	4.32	14.27	3.31	4.32	11.13	3.63	3.07	9.14	3.78	2.42	9.14	3.78	2.42	9.14	3.78	2.42
30	13.37	3.79	3.52	13.37	3.79	3.52	11.21	3.98	2.82	9.92	4.07	2.44	9.92	4.07	2.44	9.92	4.07	2.44	
35	/	/	/	/	/	/	/	/	/	/	/	/	/	/	/	/	/	/	/
70	-25	/	/	/	/	/	/	/	/	/	/	/	/	/	/	/	/	/	/
	-20	/	/	/	/	/	/	/	/	/	/	/	/	/	/	/	/	/	/
	-15	9.17	1.53	5.99	9.17	1.53	5.99	9.17	1.53	5.99	6.35	1.61	3.93	5.47	1.65	3.32	5.47	1.65	3.32
	-10	9.99	1.67	5.98	9.99	1.67	5.98	9.96	1.69	5.88	6.50	1.92	3.40	6.50	1.92	3.40	6.50	1.92	3.40
	-7	10.61	1.73	6.14	10.61	1.73	6.14	9.57	1.78	5.38	7.04	1.96	3.59	6.90	1.96	3.52	6.90	1.96	3.52
	-5	10.38	1.75	5.92	10.38	1.75	5.92	9.59	1.79	5.36	7.13	1.97	3.61	7.13	1.97	3.61	7.13	1.97	3.61
	-2	10.45	1.79	5.84	10.45	1.79	5.84	9.64	1.84	5.23	6.98	2.00	3.49	6.98	2.00	3.49	6.98	2.00	3.49
	0	10.45	1.82	5.73	10.45	1.82	5.73	9.89	1.87	5.29	7.26	2.05	3.54	7.26	2.05	3.54	7.26	2.05	3.54
	2	10.68	1.88	5.70	10.68	1.88	5.70	10.10	1.92	5.25	7.53	2.09	3.60	7.53	2.09	3.60	7.53	2.09	3.60
	5	12.90	2.13	6.07	12.90	2.13	6.07	10.65	2.19	4.87	8.44	2.38	3.55	8.44	2.38	3.55	8.44	2.38	3.55
	7	13.59	2.19	6.22	13.59	2.19	6.22	11.16	2.32	4.81	8.72	2.52	3.45	8.72	2.52	3.45	8.72	2.52	3.45
	10	13.71	2.44	5.61	13.71	2.44	5.61	11.25	2.51	4.48	8.67	2.70	3.22	8.67	2.70	3.22	8.67	2.70	3.22
	12	13.87	2.58	5.38	13.87	2.58	5.38	11.19	2.65	4.22	9.24	2.84	3.26	9.24	2.84	3.26	9.24	2.84	3.26
	15	14.32	2.64	5.42	14.32	2.64	5.42	11.23	2.90	3.87	9.82	3.04	3.23	9.82	3.04	3.23	9.82	3.04	3.23
	20	13.14	2.86	4.60	13.14	2.86	4.60	11.36	2.91	3.90	7.87	3.28	2.40	7.87	3.28	2.40	7.87	3.28	2.40
	25	13.45	3.12	4.32	13.45	3.12	4.32	11.17	3.27	3.41	9.21	3.51	2.62	9.21	3.51	2.62	9.21	3.51	2.62
30	/	/	/	/	/	/	/	/	/	/	/	/	/	/	/	/	/	/	/
35	/	/	/	/	/	/	/	/	/	/	/	/	/	/	/	/	/	/	/
75	-25	/	/	/	/	/	/	/	/	/	/	/	/	/	/	/	/	/	/
	-20	/	/	/	/	/	/	/	/	/	/	/	/	/	/	/	/	/	/
	-15	/	/	/	/	/	/	/	/	/	/	/	/	/	/	/	/	/	/
	-10	9.69	1.43	6.79	9.69	1.43	6.79	9.55	1.45	6.59	6.26	1.74	3.61	6.26	1.74	3.61	6.26	1.74	3.61
	-7	10.06	1.57	6.42	10.06	1.57	6.42	9.48	1.60	5.93	6.84	1.80	3.80	6.84	1.80	3.80	6.84	1.80	3.80
	-5	9.71	1.63	5.94	9.71	1.63	5.94	9.46	1.63	5.80	6.99	1.83	3.82	6.99	1.83	3.82	6.99	1.83	3.82
	-2	9.71	1.65	5.89	9.71	1.65	5.89	9.58	1.65	5.81	6.92	1.85	3.73	6.92	1.85	3.73	6.92	1.85	3.73
	0	9.68	1.67	5.79	9.68	1.67	5.79	9.68	1.67	5.79	7.19	1.90	3.79	7.19	1.90	3.79	7.19	1.90	3.79
	2	9.72	1.69	5.74	9.72	1.69	5.74	9.72	1.70	5.70	7.42	1.92	3.86	7.42	1.92	3.86	7.42	1.92	3.86
	5	11.59	1.89	6.15	11.59	1.89	6.15	10.56	1.92	5.50	8.12	2.13	3.82	8.12	2.13	3.82	8.12	2.13	3.82
	7	12.36	1.92	6.43	12.36	1.92	6.43	11.16	1.94	5.75	8.26	2.14	3.85	8.26	2.14	3.85	8.26	2.14	3.85
	10	11.91	2.10	5.68	11.91	2.10	5.68	11.16	2.17	5.15	8.36	2.41	3.47	8.36	2.41	3.47	8.36	2.41	3.47
	12	12.40	2.23	5.56	12.40	2.23	5.56	11.11	2.32	4.78	8.91	2.54	3.51	8.91	2.54	3.51	8.91	2.54	3.51
	15	12.88	2.31	5.57	12.88	2.31	5.57	11.15	2.50	4.46	9.54	2.72	3.51	9.54	2.72	3.51	9.54	2.72	3.51
	20	11.12	2.64	4.21	11.12	2.64	4.21	11.12	2.64	4.21	7.64	2.90	2.64	7.64	2.90	2.64	7.64	2.90	2.64
	25	/	/	/	/	/	/	/	/	/	/	/	/	/	/	/	/	/	/
30	/	/	/	/	/	/	/	/	/	/	/	/	/	/	/	/	/	/	/
35	/	/	/	/	/	/	/	/	/	/	/	/	/	/	/	/	/	/	/

Abbreviations:

LWT: Leaving water temperature (°C)

DB: Dry-bulb temperature for Outdoor air temperature (°C)

HC: Total heating capacity (kW)

PI: Power input (kW)

6.2 Cooling capacity tables (test standard: EN14511)

6 kW cooling capacity

LWT	DB	Maximum			100% (Normal)			75%			50%			25%			Minimum		
		CC	EER	PI	CC	EER	PI	CC	EER	PI	CC	EER	PI	CC	EER	PI	CC	EER	PI
5	-5	/	/	/	/	/	/	/	/	/	/	/	/	/	/	/	/	/	/
	0	/	/	/	/	/	/	/	/	/	/	/	/	/	/	/	/	/	/
	5	/	/	/	/	/	/	/	/	/	/	/	/	/	/	/	/	/	/
	10	/	/	/	/	/	/	/	/	/	/	/	/	/	/	/	/	/	/
	15	/	/	/	/	/	/	/	/	/	/	/	/	/	/	/	/	/	/
	19	5.40	5.30	1.02	5.40	5.30	1.02	4.05	5.71	0.71	2.70	6.22	0.43	2.53	6.25	0.40	2.53	6.25	0.40
	20	5.54	5.12	1.08	5.54	5.12	1.08	4.15	5.53	0.75	2.77	6.10	0.45	2.50	6.20	0.40	2.50	6.20	0.40
	25	6.10	4.22	1.45	6.10	4.22	1.45	4.57	4.69	0.98	3.05	5.15	0.59	2.38	5.32	0.45	2.38	5.32	0.45
	30	6.75	3.48	1.94	6.75	3.48	1.94	5.09	3.83	1.33	3.40	4.39	0.77	2.24	4.55	0.49	2.24	4.55	0.49
	35	6.77	2.94	2.30	6.77	2.94	2.30	5.04	3.30	1.53	3.40	3.68	0.92	2.14	3.88	0.55	2.14	3.88	0.55
	40	5.44	2.80	1.95	5.44	2.80	1.95	4.08	3.06	1.33	2.72	3.32	0.82	1.99	3.45	0.58	1.99	3.45	0.58
43	4.86	2.70	1.80	4.86	2.70	1.80	3.64	2.90	1.25	2.43	3.20	0.76	1.92	3.31	0.58	1.92	3.31	0.58	
46	4.49	2.55	1.76	4.49	2.55	1.76	3.37	2.68	1.26	2.24	2.85	0.79	1.88	2.93	0.64	1.88	2.93	0.64	
7	-5	/	/	/	/	/	/	/	/	/	/	/	/	/	/	/	/	/	
	0	/	/	/	/	/	/	/	/	/	/	/	/	/	/	/	/	/	
	5	/	/	/	/	/	/	/	/	/	/	/	/	/	/	/	/	/	
	10	/	/	/	/	/	/	/	/	/	/	/	/	/	/	/	/	/	
	15	/	/	/	/	/	/	/	/	/	/	/	/	/	/	/	/	/	
	19	5.76	5.68	1.01	5.76	5.68	1.01	4.32	6.13	0.70	2.88	6.65	0.43	2.70	6.72	0.40	2.70	6.72	0.40
	20	5.90	5.47	1.08	5.90	5.47	1.08	4.43	5.91	0.75	2.95	6.41	0.46	2.67	6.60	0.41	2.67	6.60	0.41
	25	6.50	4.52	1.44	6.50	4.52	1.44	4.88	4.93	0.99	3.25	5.42	0.60	2.54	5.73	0.44	2.54	5.73	0.44
	30	7.11	3.69	1.93	6.75	3.77	1.79	5.09	4.14	1.23	3.37	4.69	0.72	2.41	4.87	0.49	2.41	4.87	0.49
	35	7.14	3.01	2.38	6.80	3.10	2.19	5.05	3.55	1.42	3.38	4.01	0.84	2.29	4.38	0.52	2.29	4.38	0.52
	40	5.82	2.94	1.98	5.82	2.94	1.98	4.36	3.26	1.34	2.91	3.61	0.81	2.15	3.67	0.59	2.15	3.67	0.59
43	5.19	2.82	1.84	5.19	2.82	1.84	3.89	3.07	1.27	2.59	3.27	0.79	2.06	3.31	0.62	2.06	3.31	0.62	
46	4.79	2.67	1.80	4.79	2.67	1.80	3.59	2.89	1.24	2.33	3.01	0.78	2.03	3.03	0.67	2.03	3.03	0.67	
10	-5	/	/	/	/	/	/	/	/	/	/	/	/	/	/	/	/	/	
	0	/	/	/	/	/	/	/	/	/	/	/	/	/	/	/	/	/	
	5	/	/	/	/	/	/	/	/	/	/	/	/	/	/	/	/	/	
	10	/	/	/	/	/	/	/	/	/	/	/	/	/	/	/	/	/	
	15	5.72	7.05	0.81	5.72	7.05	0.81	4.33	7.60	0.57	3.08	8.04	0.38	3.08	8.04	0.38	3.08	8.04	0.38
	19	6.31	6.17	1.02	6.31	6.17	1.02	4.73	6.65	0.71	3.20	7.30	0.44	2.99	7.34	0.41	2.99	7.34	0.41
	20	6.47	5.94	1.09	6.47	5.94	1.09	4.89	6.37	0.77	3.26	7.05	0.46	2.95	7.10	0.42	2.95	7.10	0.42
	25	7.16	4.80	1.49	6.64	4.90	1.36	4.96	5.42	0.92	3.40	5.99	0.57	2.81	6.17	0.46	2.81	6.17	0.46
	30	7.80	3.96	1.97	6.75	4.17	1.62	5.04	4.67	1.08	3.36	5.23	0.64	2.67	5.39	0.50	2.67	5.39	0.50
	35	7.80	3.27	2.39	6.65	3.58	1.86	5.05	3.97	1.27	3.37	4.35	0.77	2.51	4.55	0.55	2.51	4.55	0.55
	40	6.40	3.17	2.02	6.40	3.17	2.02	4.80	3.48	1.38	3.20	3.81	0.84	2.39	4.05	0.59	2.39	4.05	0.59
43	5.70	3.01	1.89	5.70	3.01	1.89	4.26	3.32	1.28	2.81	3.55	0.79	2.30	3.68	0.62	2.30	3.68	0.62	
46	5.27	2.88	1.83	5.27	2.88	1.83	3.96	3.15	1.25	2.64	3.22	0.82	2.25	3.37	0.67	2.25	3.37	0.67	
11	-5	/	/	/	/	/	/	/	/	/	/	/	/	/	/	/	/	/	
	0	/	/	/	/	/	/	/	/	/	/	/	/	/	/	/	/	/	
	5	/	/	/	/	/	/	/	/	/	/	/	/	/	/	/	/	/	
	10	4.94	8.30	0.59	4.94	8.30	0.59	4.01	8.80	0.46	4.01	8.80	0.46	4.01	8.80	0.46	4.01	8.80	0.46
	15	5.89	7.19	0.82	5.89	7.19	0.82	4.42	7.73	0.57	3.17	8.18	0.39	3.17	8.18	0.39	3.17	8.18	0.39
	19	6.50	6.30	1.03	6.50	6.60	0.98	4.87	7.14	0.68	3.30	7.71	0.43	3.09	7.76	0.40	3.09	7.76	0.40
	20	6.68	5.93	1.13	6.68	6.23	1.07	5.05	6.73	0.75	3.38	7.27	0.46	3.05	7.35	0.42	3.05	7.35	0.42
	25	7.39	4.87	1.52	6.65	5.26	1.26	5.02	5.65	0.89	3.31	6.23	0.53	2.90	6.29	0.46	2.90	6.29	0.46
	30	7.98	4.01	1.99	6.64	4.31	1.54	5.01	4.87	1.03	3.37	5.44	0.62	2.76	5.59	0.49	2.76	5.59	0.49
	35	8.04	3.30	2.44	6.67	3.71	1.80	5.06	4.15	1.22	3.39	4.70	0.72	2.60	4.79	0.54	2.60	4.79	0.54
	40	6.61	3.21	2.06	6.61	3.21	2.06	4.95	3.60	1.37	3.30	4.05	0.82	2.47	4.20	0.59	2.47	4.20	0.59
43	5.88	3.05	1.93	5.88	3.05	1.93	4.41	3.45	1.28	2.94	3.70	0.79	2.37	3.82	0.62	2.37	3.82	0.62	
46	5.44	2.92	1.86	5.44	2.92	1.86	4.08	3.27	1.25	2.72	3.41	0.80	2.33	3.45	0.68	2.33	3.45	0.68	
15	-5	5.89	11.26	0.52	5.89	11.26	0.52	5.11	11.85	0.43	5.11	11.85	0.43	5.11	11.85	0.43	5.11	11.85	0.43
	0	5.78	11.00	0.53	5.78	11.00	0.53	5.00	11.56	0.43	4.70	11.60	0.41	4.70	11.60	0.41	4.70	11.60	0.41
	5	5.54	10.52	0.53	5.54	10.52	0.53	4.80	11.00	0.44	4.60	11.03	0.42	4.60	11.03	0.42	4.60	11.03	0.42
	10	5.40	10.18	0.53	5.40	10.18	0.53	4.46	10.66	0.42	4.46	10.66	0.42	4.46	10.66	0.42	4.46	10.66	0.42
	15	6.45	8.91	0.72	6.45	8.91	0.72	4.84	9.21	0.53	3.50	9.71	0.36	3.50	9.71	0.36	3.50	9.71	0.36
	19	7.13	7.66	0.93	6.55	7.73	0.85	4.89	8.17	0.60	3.42	8.68	0.39	3.42	8.68	0.39	3.42	8.68	0.39
	20	7.32	7.00	1.05	6.49	7.28	0.89	4.96	7.52	0.66	3.37	7.96	0.42	3.37	7.96	0.42	3.37	7.96	0.42
	25	8.30	5.47	1.52	6.50	6.03	1.08	4.86	6.57	0.74	3.28	7.09	0.46	3.28	7.09	0.46	3.28	7.09	0.46
	30	8.99	4.51	1.99	6.57	5.12	1.28	4.91	5.74	0.85	3.27	6.28	0.52	3.05	6.31	0.48	3.05	6.31	0.48
	35	8.99	3.70	2.43	6.52	4.42	1.48	4.92	4.91	1.00	3.31	5.40	0.61	2.98	5.50	0.54	2.98	5.50	0.54
	40	7.42	3.44	2.16	6.58	3.70	1.78	4.95	4.16	1.19	3.33	4.61	0.72	2.80	4.65	0.60	2.80	4.65	0.60
43	6.60	3.30	2.00	6.51	3.33	1.96	4.88	3.79	1.29	3.31	4.18	0.79	2.71	4.22	0.64	2.71	4.22	0.64	
46	6.14	3.18	1.93	6.14	3.18	1.93	4.60	3.60	1.28	3.07	3.81	0.81	2.68	3.83	0.70	2.68	3.83	0.70	

LWT	DB	Maximum			100% (Normal)			75%			50%			25%			Minimum		
		CC	EER	PI	CC	EER	PI	CC	EER	PI	CC	EER	PI	CC	EER	PI	CC	EER	PI
18	-5	6.37	12.58	0.51	6.37	12.58	0.51	5.53	12.90	0.43	5.35	13.01	0.41	5.35	13.01	0.41	5.35	13.01	0.41
	0	6.28	12.03	0.52	6.28	12.03	0.52	5.45	12.56	0.43	5.45	12.56	0.43	5.45	12.56	0.43	5.45	12.56	0.43
	5	6.02	10.76	0.56	6.02	10.76	0.56	5.60	11.02	0.51	5.60	11.02	0.51	5.60	11.02	0.51	5.60	11.02	0.51
	10	5.89	10.22	0.58	5.89	10.22	0.58	4.81	10.84	0.44	4.81	10.84	0.44	4.81	10.84	0.44	4.81	10.84	0.44
	15	7.04	9.31	0.76	6.65	9.71	0.68	4.90	10.08	0.49	3.82	10.66	0.36	3.82	10.66	0.36	3.82	10.66	0.36
	19	7.79	8.22	0.95	6.52	8.53	0.76	4.86	9.14	0.53	3.74	9.64	0.39	3.74	9.64	0.39	3.74	9.64	0.39
	20	7.98	7.70	1.04	6.47	8.22	0.79	4.81	8.65	0.56	3.70	9.19	0.40	3.70	9.19	0.40	3.70	9.19	0.40
	25	9.03	6.06	1.49	6.44	6.89	0.93	4.82	7.32	0.66	3.52	8.04	0.44	3.52	8.04	0.44	3.52	8.04	0.44
	30	9.77	4.86	2.01	6.49	5.75	1.13	4.88	6.32	0.77	3.34	6.82	0.49	3.34	6.82	0.49	3.34	6.82	0.49
	35	9.75	4.10	2.38	6.50	5.10	1.27	4.91	5.48	0.90	3.29	6.00	0.55	3.18	6.02	0.53	3.18	6.02	0.53
	40	8.07	3.70	2.18	6.45	4.33	1.49	4.88	4.64	1.05	3.21	5.16	0.62	3.09	5.24	0.59	3.09	5.24	0.59
	43	7.20	3.50	2.06	6.43	3.97	1.62	4.83	4.22	1.14	3.21	4.68	0.68	2.98	4.71	0.63	2.98	4.71	0.63
46	6.70	3.38	1.98	6.50	3.47	1.87	4.88	3.91	1.25	3.25	4.22	0.77	2.95	4.25	0.70	2.95	4.25	0.70	
20	-5	6.71	13.26	0.51	6.71	13.26	0.51	5.94	13.56	0.44	5.94	13.56	0.44	5.94	13.56	0.44	5.94	13.56	0.44
	0	6.61	12.65	0.52	6.61	12.65	0.52	5.75	13.03	0.44	5.75	13.03	0.44	5.75	13.03	0.44	5.75	13.03	0.44
	5	6.39	11.85	0.54	6.39	11.85	0.54	5.69	12.40	0.46	5.69	12.40	0.46	5.69	12.40	0.46	5.69	12.40	0.46
	10	6.23	11.43	0.55	6.23	11.43	0.55	5.19	12.03	0.43	5.19	12.03	0.43	5.19	12.03	0.43	5.19	12.03	0.43
	15	7.47	10.33	0.72	6.64	10.90	0.61	4.80	11.45	0.42	4.04	11.56	0.35	4.04	11.56	0.35	4.04	11.56	0.35
	19	8.24	9.54	0.86	6.51	9.99	0.65	4.88	10.35	0.47	3.97	10.74	0.37	3.97	10.74	0.37	3.97	10.74	0.37
	20	8.44	8.40	1.01	6.45	9.13	0.71	4.83	9.62	0.50	3.93	10.06	0.39	3.93	10.06	0.39	3.93	10.06	0.39
	25	9.54	6.74	1.42	6.47	7.85	0.82	4.86	8.23	0.59	3.74	8.73	0.43	3.74	8.73	0.43	3.74	8.73	0.43
	30	10.31	5.42	1.90	6.48	6.54	0.99	4.79	6.90	0.69	3.57	7.45	0.48	3.57	7.45	0.48	3.57	7.45	0.48
	35	10.27	4.18	2.46	6.45	5.36	1.20	4.69	5.82	0.81	3.39	6.32	0.54	3.39	6.32	0.54	3.39	6.32	0.54
	40	8.53	3.75	2.27	6.42	4.58	1.40	4.83	5.00	0.96	3.29	5.51	0.60	3.29	5.51	0.60	3.29	5.51	0.60
	43	7.62	3.56	2.14	6.51	4.10	1.59	4.91	4.51	1.09	3.18	5.02	0.63	3.18	5.02	0.63	3.18	5.02	0.63
46	7.10	3.42	2.08	6.19	3.79	1.64	4.50	4.27	1.05	3.25	4.54	0.72	3.15	4.57	0.69	3.15	4.57	0.69	
25	-5	7.83	13.55	0.58	7.83	13.55	0.58	6.88	13.87	0.50	6.88	13.87	0.50	6.88	13.87	0.50	6.88	13.87	0.50
	0	7.57	13.20	0.57	7.57	13.20	0.57	6.66	13.40	0.50	6.66	13.40	0.50	6.66	13.40	0.50	6.66	13.40	0.50
	5	7.28	12.43	0.59	7.28	12.43	0.59	6.45	12.72	0.51	6.45	12.72	0.51	6.45	12.72	0.51	6.45	12.72	0.51
	10	7.13	11.63	0.61	7.13	11.63	0.61	5.96	12.10	0.49	5.83	12.15	0.48	5.83	12.15	0.48	5.83	12.15	0.48
	15	8.58	10.20	0.84	6.44	10.96	0.59	4.87	11.37	0.43	4.67	11.53	0.40	4.67	11.53	0.40	4.67	11.53	0.40
	19	9.45	9.00	1.05	6.41	9.91	0.65	4.83	10.32	0.47	4.59	10.52	0.44	4.59	10.52	0.44	4.59	10.52	0.44
	20	9.68	8.28	1.17	6.51	9.51	0.68	4.94	9.93	0.50	4.55	10.03	0.45	4.55	10.03	0.45	4.55	10.03	0.45
	25	10.65	7.17	1.49	6.55	8.38	0.78	4.85	8.74	0.56	4.34	9.03	0.48	4.34	9.03	0.48	4.34	9.03	0.48
	30	11.79	5.61	2.10	6.45	7.83	0.82	4.83	8.10	0.60	4.13	8.39	0.49	4.13	8.39	0.49	4.13	8.39	0.49
	35	11.70	4.62	2.53	6.46	6.44	1.00	4.88	6.90	0.71	3.94	7.30	0.54	3.94	7.30	0.54	3.94	7.30	0.54
	40	9.72	4.29	2.27	6.41	5.58	1.15	4.93	5.84	0.84	3.73	6.33	0.59	3.73	6.33	0.59	3.73	6.33	0.59
	43	8.71	4.02	2.17	6.45	4.99	1.29	4.90	5.30	0.92	3.61	5.71	0.63	3.61	5.71	0.63	3.61	5.71	0.63
46	8.22	3.86	2.13	6.20	4.56	1.36	4.43	5.02	0.88	3.66	5.22	0.70	3.66	5.22	0.70	3.66	5.22	0.70	

Abbreviations:

LWT: Leaving water temperature (°C)

DB: Dry-bulb temperature for Outdoor air temperature (°C)

HC: Total cooling capacity (kW)

PI: Power input (kW)

10 kW cooling capacity

LWT	DB	Maximum			100% (Normal)			75%			50%			25%			Minimum		
		CC	EER	PI	CC	EER	PI	CC	EER	PI	CC	EER	PI	CC	EER	PI	CC	EER	PI
5	-5	/	/	/	/	/	/	/	/	/	/	/	/	/	/	/	/	/	/
	0	/	/	/	/	/	/	/	/	/	/	/	/	/	/	/	/	/	/
	5	/	/	/	/	/	/	/	/	/	/	/	/	/	/	/	/	/	/
	10	/	/	/	/	/	/	/	/	/	/	/	/	/	/	/	/	/	/
	15	/	/	/	/	/	/	/	/	/	/	/	/	/	/	/	/	/	/
	19	7.06	5.21	1.36	7.06	5.21	1.36	5.30	6.05	0.88	3.50	6.81	0.51	3.50	6.81	0.51	3.50	6.81	0.51
	20	7.23	4.97	1.45	7.23	4.97	1.45	5.41	5.75	0.94	3.61	6.53	0.55	3.47	6.56	0.53	3.47	6.56	0.53
	25	7.81	4.09	1.91	7.81	4.09	1.91	5.86	4.78	1.22	3.88	5.48	0.71	3.35	5.54	0.61	3.35	5.54	0.61
	30	8.20	3.41	2.40	8.20	3.41	2.40	6.15	4.32	1.42	4.06	4.76	0.85	3.21	4.92	0.65	3.21	4.92	0.65
	35	8.23	2.88	2.86	8.23	2.88	2.86	6.14	3.42	1.79	4.06	3.98	1.02	3.03	4.35	0.70	3.03	4.35	0.70
	40	6.76	2.77	2.44	6.76	2.77	2.44	5.02	3.06	1.64	3.32	3.42	0.97	2.85	3.62	0.79	2.85	3.62	0.79
	43	6.18	2.63	2.35	6.18	2.63	2.35	4.57	2.95	1.55	3.08	3.05	1.01	2.73	3.13	0.87	2.73	3.13	0.87
46	5.26	2.55	2.06	5.26	2.55	2.06	3.95	2.75	1.44	2.61	2.96	0.88	2.61	2.96	0.88	2.61	2.96	0.88	
7	-5	/	/	/	/	/	/	/	/	/	/	/	/	/	/	/	/	/	
	0	/	/	/	/	/	/	/	/	/	/	/	/	/	/	/	/	/	
	5	/	/	/	/	/	/	/	/	/	/	/	/	/	/	/	/	/	
	10	/	/	/	/	/	/	/	/	/	/	/	/	/	/	/	/	/	
	15	/	/	/	/	/	/	/	/	/	/	/	/	/	/	/	/	/	
	19	7.54	5.55	1.36	7.54	5.55	1.36	5.70	6.52	0.87	3.75	7.42	0.51	3.75	7.42	0.51	3.75	7.42	0.51
	20	7.72	5.29	1.46	7.72	5.29	1.46	5.65	6.32	0.89	3.86	7.07	0.55	3.72	7.14	0.52	3.72	7.14	0.52
	25	8.33	4.32	1.93	8.33	4.32	1.93	6.25	5.20	1.20	4.15	5.90	0.70	3.59	5.98	0.60	3.59	5.98	0.60
	30	8.73	3.58	2.44	8.73	3.58	2.44	6.55	4.33	1.51	4.37	4.90	0.89	3.44	4.98	0.69	3.44	4.98	0.69
	35	9.23	3.06	3.01	8.90	3.25	2.74	6.57	3.62	1.81	4.38	4.15	1.06	3.25	4.42	0.74	3.25	4.42	0.74
	40	7.23	2.92	2.48	7.23	2.92	2.48	5.58	3.30	1.69	3.69	3.66	1.01	3.06	3.80	0.80	3.06	3.80	0.80
	43	6.60	2.76	2.39	6.60	2.76	2.39	4.95	3.15	1.57	3.30	3.33	0.99	2.94	3.37	0.87	2.94	3.37	0.87
46	5.63	2.68	2.10	5.63	2.68	2.10	4.22	2.95	1.43	2.81	3.10	0.91	2.81	3.10	0.91	2.81	3.10	0.91	
10	-5	/	/	/	/	/	/	/	/	/	/	/	/	/	/	/	/	/	
	0	/	/	/	/	/	/	/	/	/	/	/	/	/	/	/	/	/	
	5	/	/	/	/	/	/	/	/	/	/	/	/	/	/	/	/	/	
	10	/	/	/	/	/	/	/	/	/	/	/	/	/	/	/	/	/	
	15	7.48	6.95	1.08	7.48	6.95	1.08	5.55	7.96	0.70	4.19	8.85	0.47	4.19	8.85	0.47	4.19	8.85	0.47
	19	8.30	6.11	1.36	8.30	6.11	1.36	6.16	7.28	0.85	4.15	8.10	0.51	4.15	8.10	0.51	4.15	8.10	0.51
	20	8.49	5.83	1.46	8.49	5.83	1.46	6.37	6.82	0.93	4.28	7.21	0.59	4.12	7.25	0.57	4.12	7.25	0.57
	25	9.15	4.68	1.96	9.15	4.68	1.96	6.76	5.90	1.15	4.59	6.61	0.69	3.98	6.75	0.59	3.98	6.75	0.59
	30	9.58	3.84	2.49	9.21	3.89	2.37	6.88	4.84	1.42	4.56	5.53	0.82	3.81	5.80	0.66	3.81	5.80	0.66
	35	9.60	3.22	2.98	9.20	3.30	2.79	6.87	4.06	1.69	4.57	4.63	0.99	3.61	4.96	0.73	3.61	4.96	0.73
	40	7.95	3.13	2.54	7.95	3.13	2.54	5.94	3.64	1.63	3.95	4.30	0.92	3.40	4.38	0.78	3.40	4.38	0.78
	43	7.26	2.96	2.45	7.26	2.96	2.45	5.55	3.42	1.62	3.67	4.00	0.92	3.25	4.09	0.79	3.25	4.09	0.79
46	6.20	2.89	2.14	6.20	2.89	2.14	4.65	3.12	1.49	3.12	3.61	0.86	3.12	3.61	0.86	3.12	3.61	0.86	
11	-5	/	/	/	/	/	/	/	/	/	/	/	/	/	/	/	/	/	
	0	/	/	/	/	/	/	/	/	/	/	/	/	/	/	/	/	/	
	5	/	/	/	/	/	/	/	/	/	/	/	/	/	/	/	/	/	
	10	6.74	7.92	0.85	6.74	7.92	0.85	5.15	9.21	0.56	5.15	9.21	0.56	5.15	9.21	0.56	5.15	9.21	0.56
	15	7.71	7.21	1.07	7.71	7.21	1.07	5.10	8.37	0.61	4.33	8.92	0.49	4.09	8.96	0.46	4.09	8.96	0.46
	19	8.56	6.16	1.39	8.56	6.16	1.39	6.36	7.65	0.83	4.29	8.41	0.51	4.06	8.48	0.48	4.06	8.48	0.48
	20	8.76	5.97	1.47	8.76	5.97	1.47	6.59	6.89	0.96	4.43	7.60	0.58	4.26	7.62	0.56	4.26	7.62	0.56
	25	9.43	4.88	1.93	9.43	4.88	1.93	6.93	5.96	1.16	4.59	6.87	0.67	4.12	7.02	0.59	4.12	7.02	0.59
	30	9.86	3.93	2.51	9.30	4.02	2.31	6.98	4.87	1.43	4.71	5.74	0.82	3.94	6.02	0.66	3.94	6.02	0.66
	35	9.90	3.29	3.01	9.26	3.52	2.63	6.98	4.26	1.64	4.60	4.83	0.95	3.74	5.10	0.73	3.74	5.10	0.73
	40	8.17	3.19	2.57	8.17	3.19	2.57	6.13	3.68	1.67	4.09	4.13	0.99	3.52	4.25	0.83	3.52	4.25	0.83
	43	7.50	3.03	2.47	7.50	3.03	2.47	6.13	3.45	1.78	4.08	3.87	1.05	3.38	3.96	0.85	3.38	3.96	0.85
46	7.20	2.92	2.47	7.20	2.92	2.47	5.40	3.23	1.67	3.60	3.43	1.05	3.23	3.45	0.94	3.23	3.45	0.94	
15	-5	8.12	12.09	0.67	8.12	12.09	0.67	6.54	12.60	0.52	6.54	12.60	0.52	6.54	12.60	0.52	6.54	12.60	0.52
	0	8.05	10.55	0.76	8.05	10.55	0.76	5.71	11.45	0.50	5.71	11.45	0.50	5.71	11.45	0.50	5.71	11.45	0.50
	5	7.82	9.60	0.81	7.82	9.60	0.81	5.58	10.52	0.53	5.58	10.52	0.53	5.58	10.52	0.53	5.58	10.52	0.53
	10	7.65	8.84	0.86	7.65	8.84	0.86	5.14	9.65	0.53	5.14	9.65	0.53	5.14	9.65	0.53	5.14	9.65	0.53
	15	8.79	7.79	1.13	8.79	8.02	1.10	7.25	8.86	0.82	4.71	9.43	0.50	4.71	9.43	0.50	4.71	9.43	0.50
	19	9.69	6.82	1.42	9.69	6.82	1.42	7.21	7.87	0.92	4.87	8.91	0.55	4.87	8.91	0.55	4.87	8.91	0.55
	20	9.91	6.10	1.62	9.61	6.32	1.52	7.31	7.35	0.99	4.84	8.40	0.58	4.84	8.40	0.58	4.84	8.40	0.58
	25	10.66	5.35	1.99	9.67	5.74	1.68	7.29	6.85	1.06	4.85	7.65	0.63	4.67	7.71	0.61	4.67	7.71	0.61
	30	11.11	4.31	2.58	9.68	4.87	1.99	7.31	5.83	1.25	4.82	6.41	0.75	4.48	6.72	0.67	4.48	6.72	0.67
	35	11.16	3.58	3.12	9.67	4.02	2.41	7.20	4.79	1.50	4.91	5.31	0.92	4.27	5.62	0.76	4.27	5.62	0.76
	40	9.25	3.49	2.65	9.25	3.49	2.65	6.82	4.22	1.62	4.66	4.59	1.02	4.03	4.73	0.85	4.03	4.73	0.85
	43	8.49	3.33	2.55	8.49	3.33	2.55	6.34	3.92	1.62	4.17	4.06	1.03	3.87	4.27	0.91	3.87	4.27	0.91
46	8.20	3.08	2.66	8.08	3.11	2.60	6.06	3.61	1.68	4.04	3.89	1.04	3.71	3.90	0.95	3.71	3.90	0.95	

LWT	DB	Maximum			100% (Normal)			75%			50%			25%			Minimum		
		CC	EER	PI	CC	EER	PI	CC	EER	PI	CC	EER	PI	CC	EER	PI	CC	EER	PI
18	-5	8.89	12.68	0.70	8.89	12.68	0.70	7.55	13.19	0.57	7.55	13.19	0.57	7.55	13.19	0.57	7.55	13.19	0.57
	0	8.79	11.52	0.76	8.79	11.52	0.76	6.26	12.35	0.51	6.26	12.35	0.51	6.26	12.35	0.51	6.26	12.35	0.51
	5	8.54	10.44	0.82	8.54	10.44	0.82	6.13	11.50	0.53	6.13	11.50	0.53	6.13	11.50	0.53	6.13	11.50	0.53
	10	8.36	9.36	0.89	8.36	9.36	0.89	6.27	10.66	0.59	5.70	10.84	0.53	5.70	10.84	0.53	5.70	10.84	0.53
	15	9.61	8.48	1.13	9.61	8.48	1.13	7.20	9.58	0.75	5.51	10.05	0.55	5.51	10.05	0.55	5.51	10.05	0.55
	19	10.60	7.36	1.44	9.92	7.62	1.30	7.56	8.87	0.85	5.35	9.14	0.58	5.35	9.14	0.58	5.35	9.14	0.58
	20	10.83	6.72	1.61	9.90	6.90	1.43	7.49	8.00	0.94	5.31	8.46	0.63	5.31	8.46	0.63	5.31	8.46	0.63
	25	11.55	5.70	2.03	9.89	6.51	1.52	7.52	7.23	1.04	5.13	7.99	0.64	5.13	7.99	0.64	5.13	7.99	0.64
	30	12.11	4.60	2.63	9.99	5.49	1.82	7.42	6.70	1.11	4.93	7.41	0.66	4.93	7.41	0.66	4.93	7.41	0.66
	35	12.13	3.79	3.20	10.00	4.75	2.11	7.48	5.51	1.36	5.04	6.23	0.81	4.69	6.27	0.75	4.69	6.27	0.75
	40	10.09	3.73	2.71	9.98	3.77	2.65	7.48	4.58	1.63	4.96	5.13	0.97	4.43	5.23	0.85	4.43	5.23	0.85
	43	9.28	3.56	2.61	9.28	3.56	2.61	6.96	4.25	1.64	4.59	4.71	0.97	4.28	4.73	0.90	4.28	4.73	0.90
46	7.96	3.52	2.26	7.96	3.52	2.26	5.97	4.09	1.46	4.10	4.26	0.96	4.10	4.26	0.96	4.10	4.26	0.96	
20	-5	9.40	13.16	0.71	9.40	13.16	0.71	8.01	13.81	0.58	8.01	13.81	0.58	8.01	13.81	0.58	8.01	13.81	0.58
	0	9.32	12.11	0.77	9.32	12.11	0.77	5.60	12.75	0.59	5.60	12.75	0.59	5.60	12.75	0.59	5.60	12.75	0.59
	5	9.05	11.07	0.82	9.05	11.07	0.82	6.70	12.05	0.59	6.70	12.05	0.59	6.70	12.05	0.59	6.70	12.05	0.59
	10	8.88	10.28	0.86	8.88	10.28	0.86	6.45	11.19	0.64	6.45	11.19	0.64	6.45	11.19	0.64	6.45	11.19	0.64
	15	10.19	9.23	1.10	10.19	9.23	1.10	7.50	10.21	0.73	7.00	10.35	0.68	7.00	10.35	0.68	7.00	10.35	0.68
	19	11.23	8.14	1.38	9.99	8.67	1.15	7.46	9.42	0.79	5.98	9.89	0.60	5.98	9.89	0.60	5.98	9.89	0.60
	20	11.52	7.25	1.59	9.89	8.01	1.23	7.41	8.55	0.87	5.89	8.79	0.67	5.89	8.79	0.67	5.89	8.79	0.67
	25	12.23	6.15	1.99	10.03	7.02	1.43	7.48	7.75	0.97	5.47	8.34	0.66	5.47	8.34	0.66	5.47	8.34	0.66
	30	12.80	5.08	2.52	9.97	6.75	1.48	7.55	7.21	1.05	5.25	7.70	0.68	5.25	7.70	0.68	5.25	7.70	0.68
	35	12.81	4.05	3.16	9.94	5.15	1.93	7.48	6.23	1.20	5.00	6.76	0.74	5.00	6.76	0.74	5.00	6.76	0.74
	40	10.68	3.89	2.75	9.95	4.16	2.39	7.54	5.00	1.51	5.09	5.55	0.92	4.71	5.60	0.84	4.71	5.60	0.84
	43	9.89	3.78	2.62	9.89	3.78	2.62	7.38	4.49	1.64	5.07	4.94	1.03	4.53	5.04	0.90	4.53	5.04	0.90
46	8.43	3.68	2.29	8.43	3.68	2.29	6.32	4.34	1.46	4.36	4.55	0.96	4.36	4.55	0.96	4.36	4.55	0.96	
25	-5	11.00	13.48	0.82	11.00	13.48	0.82	9.21	14.15	0.65	9.21	14.15	0.65	9.21	14.15	0.65	9.21	14.15	0.65
	0	10.67	12.80	0.83	10.67	12.80	0.83	8.27	13.85	0.60	8.27	13.85	0.60	8.27	13.85	0.60	8.27	13.85	0.60
	5	10.40	12.16	0.86	10.40	12.16	0.86	8.50	12.81	0.66	8.26	12.90	0.64	8.26	12.90	0.64	8.26	12.90	0.64
	10	10.24	11.65	0.88	10.24	11.65	0.88	8.28	12.00	0.69	7.78	12.12	0.64	7.78	12.12	0.64	7.78	12.12	0.64
	15	11.73	10.48	1.12	10.07	11.02	0.91	7.48	11.44	0.65	7.31	11.50	0.64	7.31	11.50	0.64	7.31	11.50	0.64
	19	12.47	9.69	1.29	9.92	10.01	0.99	7.48	10.58	0.71	6.93	10.75	0.64	6.93	10.75	0.64	6.93	10.75	0.64
	20	12.17	8.52	1.43	9.92	9.50	1.04	7.61	9.97	0.76	6.51	10.36	0.63	6.51	10.36	0.63	6.51	10.36	0.63
	25	12.49	7.65	1.63	10.05	8.52	1.18	7.39	9.28	0.80	6.35	9.75	0.65	6.35	9.75	0.65	6.35	9.75	0.65
	30	13.00	6.55	1.98	10.03	7.94	1.26	7.58	8.53	0.89	6.11	9.15	0.67	6.11	9.15	0.67	6.11	9.15	0.67
	35	13.63	5.13	2.66	9.87	6.64	1.49	7.60	7.75	0.98	5.79	8.13	0.71	5.79	8.13	0.71	5.79	8.13	0.71
	40	11.99	4.36	2.75	10.00	5.39	1.85	7.55	6.27	1.20	5.49	6.68	0.82	5.49	6.68	0.82	5.49	6.68	0.82
	43	11.27	4.13	2.73	9.95	4.80	2.07	7.46	5.36	1.39	5.29	5.98	0.88	5.29	5.98	0.88	5.29	5.98	0.88
46	9.70	3.95	2.46	9.70	3.95	2.46	7.27	4.70	1.55	5.08	5.36	0.95	5.08	5.36	0.95	5.08	5.36	0.95	

Abbreviations:

LWT: Leaving water temperature (°C)

DB: Dry-bulb temperature for Outdoor air temperature (°C)

HC: Total cooling capacity (kW)

PI: Power input (kW)

16 kW cooling capacity

LWT	DB	Maximum			100% (Normal)			75%			50%			25%			Minimum		
		CC	EER	PI	CC	EER	PI	CC	EER	PI	CC	EER	PI	CC	EER	PI	CC	EER	PI
5	-5	/	/	/	/	/	/	/	/	/	/	/	/	/	/	/	/	/	/
	0	/	/	/	/	/	/	/	/	/	/	/	/	/	/	/	/	/	/
	5	/	/	/	/	/	/	/	/	/	/	/	/	/	/	/	/	/	/
	10	/	/	/	/	/	/	/	/	/	/	/	/	/	/	/	/	/	/
	15	/	/	/	/	/	/	/	/	/	/	/	/	/	/	/	/	/	/
	19	11.00	4.80	2.29	11.00	4.80	2.29	10.48	4.95	2.12	7.01	5.48	1.28	4.46	5.93	0.75	4.46	5.93	0.75
	20	11.22	4.57	2.45	11.22	4.57	2.45	10.56	4.76	2.22	6.95	5.31	1.31	4.44	5.74	0.77	4.44	5.74	0.77
	25	12.16	3.62	3.36	12.16	3.62	3.36	10.54	4.04	2.61	6.98	4.52	1.54	4.27	4.92	0.87	4.27	4.92	0.87
	30	13.12	2.95	4.44	13.12	2.95	4.44	10.54	3.47	3.04	7.07	3.88	1.82	4.12	4.26	0.97	4.12	4.26	0.97
	35	13.41	2.55	5.26	13.41	2.55	5.26	10.46	2.99	3.50	6.92	3.34	2.08	3.90	3.66	1.07	3.90	3.66	1.07
	40	10.48	2.51	4.17	10.48	2.51	4.17	10.48	2.51	4.17	6.98	2.85	2.45	3.71	3.17	1.17	3.71	3.17	1.17
43	9.13	2.39	3.82	9.13	2.39	3.82	9.13	2.39	3.82	7.02	2.64	2.66	3.57	2.89	1.23	3.57	2.89	1.23	
46	7.02	2.28	3.08	7.02	2.28	3.08	7.02	2.28	3.08	7.02	2.28	3.08	3.48	2.67	1.30	3.48	2.67	1.30	
7	-5	/	/	/	/	/	/	/	/	/	/	/	/	/	/	/	/	/	
	0	/	/	/	/	/	/	/	/	/	/	/	/	/	/	/	/	/	/
	5	/	/	/	/	/	/	/	/	/	/	/	/	/	/	/	/	/	/
	10	/	/	/	/	/	/	/	/	/	/	/	/	/	/	/	/	/	/
	15	/	/	/	/	/	/	/	/	/	/	/	/	/	/	/	/	/	/
	19	11.72	5.10	2.30	11.72	5.10	2.30	10.61	5.43	1.95	7.08	5.97	1.19	4.79	6.39	0.75	4.79	6.39	0.75
	20	11.95	4.84	2.47	11.95	4.84	2.47	10.52	5.27	1.99	7.02	5.60	1.25	4.76	6.18	0.77	4.76	6.18	0.77
	25	12.93	3.80	3.40	12.93	3.80	3.40	10.55	4.44	2.38	7.08	4.88	1.45	4.57	5.28	0.87	4.57	5.28	0.87
	30	13.94	3.09	4.52	13.94	3.09	4.52	10.44	3.83	2.73	7.01	4.18	1.68	4.40	4.55	0.97	4.40	4.55	0.97
	35	14.26	2.60	5.48	14.00	2.75	5.09	10.72	3.23	3.32	7.06	3.64	1.94	4.17	3.90	1.07	4.17	3.90	1.07
	40	11.13	2.61	4.26	11.13	2.61	4.26	10.43	2.78	3.74	6.99	3.13	2.23	3.97	3.37	1.18	3.97	3.37	1.18
43	9.71	2.50	3.89	9.71	2.50	3.89	9.71	2.50	3.89	7.09	2.81	2.52	3.82	3.07	1.24	3.82	3.07	1.24	
46	7.48	2.38	3.15	7.48	2.38	3.15	7.48	2.38	3.15	7.00	2.43	2.89	3.72	2.83	1.31	3.72	2.83	1.31	
10	-5	/	/	/	/	/	/	/	/	/	/	/	/	/	/	/	/	/	/
	0	/	/	/	/	/	/	/	/	/	/	/	/	/	/	/	/	/	/
	5	/	/	/	/	/	/	/	/	/	/	/	/	/	/	/	/	/	/
	10	/	/	/	/	/	/	/	/	/	/	/	/	/	/	/	/	/	/
	15	11.32	6.79	1.67	11.32	6.79	1.67	10.90	7.13	1.53	7.16	7.78	0.92	5.41	8.37	0.65	5.41	8.37	0.65
	19	12.86	5.57	2.31	12.86	5.57	2.31	11.05	6.21	1.78	7.36	7.03	1.05	5.33	7.37	0.72	5.33	7.37	0.72
	20	13.12	5.28	2.49	13.12	5.28	2.49	10.95	6.01	1.82	7.29	6.65	1.10	5.29	7.10	0.74	5.29	7.10	0.74
	25	14.16	4.10	3.46	14.16	4.10	3.46	11.02	4.89	2.25	7.38	5.53	1.34	5.05	5.89	0.86	5.05	5.89	0.86
	30	15.23	3.29	4.62	14.50	3.45	4.20	10.94	4.28	2.56	7.33	4.64	1.58	4.85	5.04	0.96	4.85	5.04	0.96
	35	15.55	2.76	5.63	14.61	2.89	5.06	11.03	3.59	3.07	7.40	4.02	1.84	4.60	4.29	1.07	4.60	4.29	1.07
	40	12.23	2.73	4.48	12.23	2.73	4.48	11.10	3.01	3.68	7.33	3.42	2.14	4.38	3.69	1.19	4.38	3.69	1.19
43	10.67	2.69	3.97	10.67	2.69	3.97	10.67	2.69	3.97	7.31	3.06	2.39	4.22	3.35	1.26	4.22	3.35	1.26	
46	8.24	2.55	3.23	8.24	2.55	3.23	8.24	2.55	3.23	7.27	2.79	2.60	4.12	3.10	1.33	4.12	3.10	1.33	
11	-5	/	/	/	/	/	/	/	/	/	/	/	/	/	/	/	/	/	/
	0	/	/	/	/	/	/	/	/	/	/	/	/	/	/	/	/	/	/
	5	/	/	/	/	/	/	/	/	/	/	/	/	/	/	/	/	/	/
	10	10.22	8.84	1.16	10.22	8.84	1.16	9.86	8.94	1.10	7.67	9.69	0.79	7.23	9.99	0.72	7.23	9.99	0.72
	15	11.67	7.00	1.67	11.67	7.00	1.67	10.83	7.18	1.51	7.38	8.08	0.91	5.60	8.76	0.64	5.60	8.76	0.64
	19	13.26	5.74	2.31	13.26	5.74	2.31	11.19	6.51	1.72	7.32	7.20	1.02	5.48	7.63	0.72	5.48	7.63	0.72
	20	13.52	5.43	2.49	13.52	5.43	2.49	11.09	6.30	1.76	7.53	6.91	1.09	5.47	7.41	0.74	5.47	7.41	0.74
	25	14.58	4.19	3.48	14.58	4.19	3.48	11.17	5.21	2.15	7.40	5.80	1.28	5.25	6.17	0.85	5.25	6.17	0.85
	30	15.68	3.37	4.66	14.78	3.47	4.26	11.09	4.44	2.50	7.36	4.87	1.51	5.00	5.21	0.96	5.00	5.21	0.96
	35	15.99	2.81	5.69	14.90	2.93	5.09	11.04	3.76	2.94	7.44	4.15	1.79	4.79	4.47	1.07	4.79	4.47	1.07
	40	12.64	2.78	4.55	12.64	2.78	4.55	11.19	3.17	3.53	7.41	3.54	2.09	4.61	3.86	1.20	4.61	3.86	1.20
43	10.99	2.74	4.01	10.99	2.74	4.01	10.99	2.74	4.01	7.37	3.17	2.33	4.45	3.51	1.27	4.45	3.51	1.27	
46	8.51	2.60	3.27	8.51	2.60	3.27	8.51	2.60	3.27	7.36	2.92	2.52	4.26	3.19	1.33	4.26	3.19	1.33	
15	-5	10.45	12.55	0.83	10.45	12.55	0.83	10.45	12.55	0.83	8.90	13.65	0.65	8.90	13.65	0.65	8.90	13.65	0.65
	0	10.50	11.74	0.89	10.50	11.74	0.89	10.50	11.74	0.89	8.91	12.86	0.69	8.91	12.86	0.69	8.91	12.86	0.69
	5	10.81	10.66	1.01	10.81	10.66	1.01	10.81	10.66	1.01	8.89	11.83	0.75	8.89	11.83	0.75	8.89	11.83	0.75
	10	11.46	9.04	1.27	11.46	9.04	1.27	10.76	9.34	1.15	8.52	10.46	0.81	8.19	10.75	0.76	8.19	10.75	0.76
	15	13.11	7.97	1.64	13.11	7.97	1.64	11.45	8.61	1.33	7.58	10.06	0.75	6.39	10.59	0.60	6.39	10.59	0.60
	19	14.94	6.46	2.31	14.94	6.46	2.31	11.64	7.90	1.47	7.82	8.95	0.87	6.28	9.19	0.68	6.28	9.19	0.68
	20	15.19	6.09	2.49	15.19	6.09	2.49	11.59	7.68	1.51	7.76	8.58	0.90	6.22	8.77	0.71	6.22	8.77	0.71
	25	16.41	4.62	3.55	15.43	4.88	3.16	11.73	6.20	1.89	7.64	6.98	1.09	5.95	7.18	0.83	5.95	7.18	0.83
	30	17.63	3.68	4.80	15.43	4.21	3.66	11.74	5.24	2.24	7.90	5.91	1.34	5.69	6.34	0.90	5.69	6.34	0.90
	35	17.42	3.07	5.68	15.45	3.50	4.41	11.72	4.36	2.69	7.77	4.90	1.59	5.39	5.18	1.04	5.39	5.18	1.04
	40	14.12	3.14	4.50	14.12	3.14	4.50	11.63	3.65	3.19	7.78	4.10	1.90	5.11	4.36	1.17	5.11	4.36	1.17
43	12.33	3.00	4.12	12.33	3.00	4.12	11.74	3.25	3.62	7.73	3.60	2.15	4.93	3.87	1.27	4.93	3.87	1.27	
46	9.56	2.89	3.31	9.56	2.89	3.31	9.56	2.89	3.31	7.73	3.25	2.38	4.83	3.59	1.35	4.83	3.59	1.35	

LWT	DB	Maximum			100% (Normal)			75%			50%			25%			Minimum		
		CC	EER	PI	CC	EER	PI	CC	EER	PI	CC	EER	PI	CC	EER	PI	CC	EER	PI
18	-5	11.10	13.06	0.85	11.10	13.06	0.85	11.10	13.06	0.85	9.72	14.10	0.69	9.72	14.10	0.69	9.72	14.10	0.69
	0	11.44	12.66	0.90	11.44	12.66	0.90	11.44	12.66	0.90	9.74	13.70	0.71	9.74	13.70	0.71	9.74	13.70	0.71
	5	11.79	12.02	0.98	11.79	12.02	0.98	11.79	12.02	0.98	9.71	13.13	0.74	9.71	13.13	0.74	9.71	13.13	0.74
	10	12.30	10.91	1.13	12.30	10.91	1.13	11.45	11.46	1.00	9.25	12.11	0.76	8.95	12.30	0.73	8.95	12.30	0.73
	15	14.30	8.45	1.69	14.30	8.45	1.69	11.91	10.01	1.19	8.04	10.86	0.74	7.04	11.34	0.62	7.04	11.34	0.62
	19	16.28	7.11	2.29	16.04	7.21	2.22	11.97	9.21	1.30	8.03	10.38	0.77	6.99	10.49	0.67	6.99	10.49	0.67
	20	16.58	6.61	2.51	16.12	6.80	2.37	11.96	8.51	1.41	7.96	9.80	0.81	6.94	10.00	0.69	6.94	10.00	0.69
	25	17.81	4.93	3.61	16.04	5.57	2.88	12.14	7.19	1.69	8.11	8.09	1.00	6.63	8.33	0.80	6.63	8.33	0.80
	30	19.18	3.91	4.90	16.00	4.72	3.39	12.13	5.97	2.03	8.12	6.72	1.21	6.34	6.87	0.92	6.34	6.87	0.92
	35	18.64	3.32	5.62	16.00	3.90	4.10	12.15	4.90	2.48	7.99	5.50	1.45	6.08	5.72	1.06	6.08	5.72	1.06
	40	15.34	3.34	4.59	15.34	3.34	4.59	12.17	4.10	2.97	8.06	4.47	1.80	5.61	5.01	1.12	5.61	5.01	1.12
	43	13.42	3.10	4.33	13.42	3.10	4.33	12.09	3.50	3.45	8.04	4.01	2.00	5.50	4.34	1.27	5.50	4.34	1.27
46	10.43	2.99	3.49	10.43	2.99	3.49	10.43	2.99	3.49	8.00	3.57	2.24	5.31	3.93	1.35	5.31	3.93	1.35	
LWT	DB	Maximum			100% (Normal)			75%			50%			25%			Minimum		
		CC	EER	PI	CC	EER	PI	CC	EER	PI	CC	EER	PI	CC	EER	PI	CC	EER	PI
20	-5	11.73	13.53	0.87	11.73	13.53	0.87	11.73	13.51	0.87	10.31	15.42	0.67	10.31	15.42	0.67	10.31	15.42	0.67
	0	12.10	13.22	0.92	12.10	13.22	0.92	12.10	13.21	0.92	10.32	14.96	0.69	10.32	14.96	0.69	10.32	14.96	0.69
	5	12.49	12.65	0.99	12.49	12.65	0.99	12.09	12.75	0.95	10.29	14.20	0.73	10.29	14.20	0.73	10.29	14.20	0.73
	10	13.03	11.38	1.15	13.03	11.38	1.15	12.02	11.76	1.02	9.49	13.12	0.72	9.49	13.12	0.72	9.49	13.12	0.72
	15	15.21	9.02	1.69	15.21	9.02	1.69	12.12	10.04	1.21	8.00	11.04	0.72	7.47	11.50	0.65	7.47	11.50	0.65
	19	17.23	7.19	2.40	15.96	7.70	2.07	12.23	9.31	1.31	7.96	10.44	0.76	7.42	10.60	0.70	7.42	10.60	0.70
	20	17.53	6.63	2.64	16.06	7.31	2.20	12.12	8.78	1.38	8.16	10.08	0.81	7.39	10.40	0.71	7.39	10.40	0.71
	25	18.77	5.15	3.65	16.30	6.20	2.63	12.09	7.58	1.59	8.08	8.90	0.91	7.07	9.13	0.77	7.07	9.13	0.77
	30	20.11	4.04	4.98	16.17	5.29	3.06	12.06	6.59	1.83	8.08	7.02	1.15	6.80	7.41	0.92	6.80	7.41	0.92
	35	19.54	3.42	5.72	16.06	4.29	3.74	11.91	5.46	2.18	7.98	5.86	1.36	6.48	6.18	1.05	6.48	6.18	1.05
	40	16.22	3.36	4.82	16.05	3.36	4.77	12.00	4.32	2.78	8.09	4.80	1.68	5.96	5.21	1.14	5.96	5.21	1.14
	43	14.18	3.33	4.26	14.18	3.33	4.26	12.02	4.03	2.98	8.08	4.07	1.98	5.87	4.65	1.26	5.87	4.65	1.26
46	10.97	3.22	3.41	10.97	3.22	3.41	10.97	3.22	3.41	8.00	3.76	2.13	5.65	4.18	1.35	5.65	4.18	1.35	
LWT	DB	Maximum			100% (Normal)			75%			50%			25%			Minimum		
		CC	EER	PI	CC	EER	PI	CC	EER	PI	CC	EER	PI	CC	EER	PI	CC	EER	PI
25	-5	12.86	13.97	0.92	12.86	13.97	0.92	12.86	13.97	0.92	11.90	15.49	0.77	11.90	15.49	0.77	11.90	15.49	0.77
	0	13.18	13.51	0.98	13.18	13.51	0.98	13.18	13.51	0.98	11.91	15.11	0.79	11.91	15.11	0.79	11.91	15.11	0.79
	5	13.61	12.97	1.05	13.61	12.97	1.05	12.88	13.50	0.82	11.88	14.47	0.82	11.88	14.47	0.82	11.88	14.47	0.82
	10	14.26	11.90	1.20	14.26	11.90	1.20	11.82	12.43	0.95	10.97	13.39	0.82	10.97	13.39	0.82	10.97	13.39	0.82
	15	16.62	9.82	1.69	15.82	10.16	1.56	11.99	11.34	1.06	8.70	12.26	0.71	8.70	12.26	0.71	8.70	12.26	0.71
	19	18.72	8.62	2.17	16.23	9.36	1.73	12.13	10.30	1.18	8.66	11.26	0.77	8.66	11.26	0.77	8.66	11.26	0.77
	20	19.02	7.98	2.38	16.08	8.97	1.79	12.02	9.79	1.23	8.62	10.70	0.81	8.62	10.70	0.81	8.62	10.70	0.81
	25	20.27	5.72	3.54	16.17	7.34	2.20	12.15	8.26	1.47	8.23	9.25	0.89	8.23	9.25	0.89	8.23	9.25	0.89
	30	21.60	4.40	4.91	16.15	6.29	2.57	12.13	7.48	1.62	7.96	8.15	0.98	7.82	8.21	0.95	7.82	8.21	0.95
	35	20.92	3.69	5.66	16.09	5.51	2.92	12.08	6.76	1.79	7.87	7.48	1.05	7.55	7.52	1.00	7.55	7.52	1.00
	40	17.54	3.58	4.89	16.06	4.45	3.61	12.04	5.63	2.14	8.02	6.14	1.31	6.92	6.72	1.03	6.92	6.72	1.03
	43	15.34	3.68	4.17	15.34	3.68	4.17	12.11	4.50	2.69	8.04	5.56	1.45	6.83	6.02	1.13	6.83	6.02	1.13
46	12.06	3.42	3.53	12.06	3.42	3.53	12.00	3.60	3.33	8.00	4.61	1.74	6.58	4.89	1.35	6.58	4.89	1.35	

Abbreviations:

LWT: Leaving water temperature (°C)

DB: Dry-bulb temperature for Outdoor air temperature (°C)

HC: Total cooling capacity (kW)

PI: Power input (kW)

7 Sound levels

7.1 Overall

Sound pressure levels¹

Model name	dB(A) ²
6 kW - 1ph	46
10 kW - 1ph	49
16 kW - 3ph	56

Notes:

- Sound pressure level is measured at a position 1m in front of the unit and $(1+H)/2$ m (where H is the highest of the unit) above the floor in a semi-anechoic chamber. During on-site operation, sound pressure levels may be higher as a result of ambient noise.

Sound pressure level measurement (unit: mm)

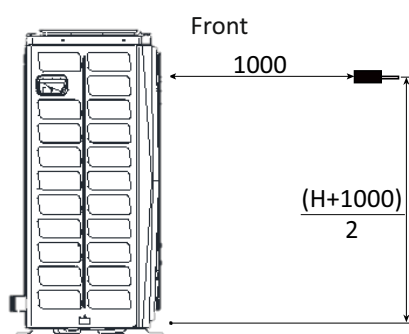

- dB(A) is the maximum value tested under the conditions below:

Outdoor air temperature 7°C DB, 85% R.H.; EWT 30°C, LWT 35°C. Free compressor frequency.

7.2 Octave band levels

We measure noise of the unit from 4 sides as below, with a rated frequency at the distance of 1 m.



The conditions we've tested is illustrated as below:

Heating A-7W35: Evaporator air in -7°C , 85% R.H.; Condenser water in/out $30/35^{\circ}\text{C}$.

Heating A7W35: Evaporator air in 7°C , 85% R.H.; Condenser water in/out $30/35^{\circ}\text{C}$.

Heating A7W45: Evaporator air in 7°C , 85% R.H.; Condenser water in/out $40/45^{\circ}\text{C}$.

Heating A7W55: Evaporator air in 7°C , 85% R.H.; Condenser water in/out $47/55^{\circ}\text{C}$.

Cooling A35W18: Condenser air in 35°C ; Evaporator water in/out $23/18^{\circ}\text{C}$.

Cooling A35W7: Condenser air in 35°C ; Evaporator water in/out $12/7^{\circ}\text{C}$.

7.2.1 Octave band levels for 6 kW unit

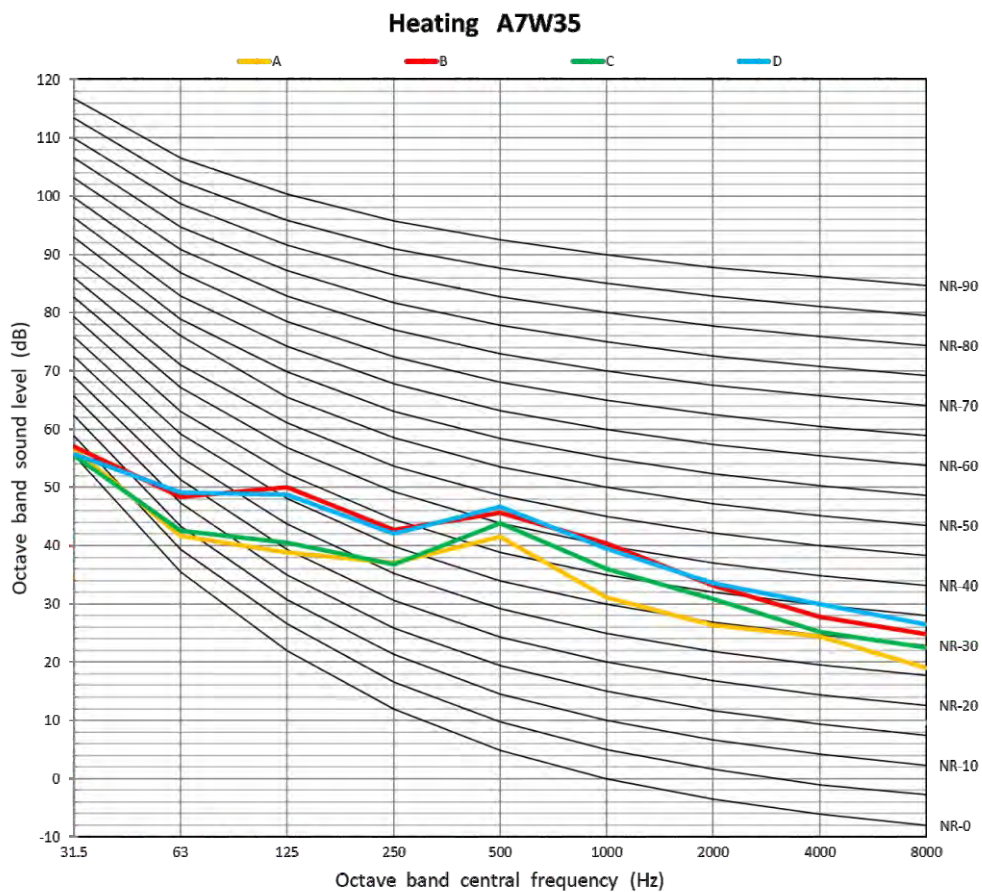
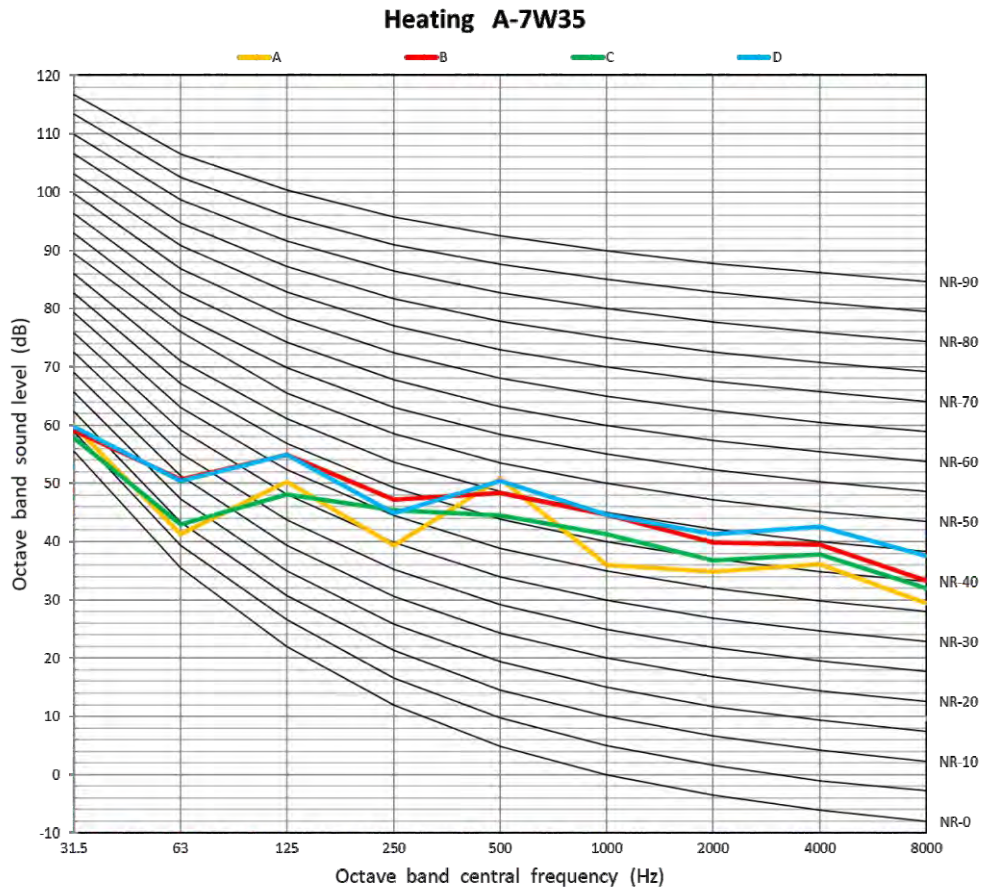

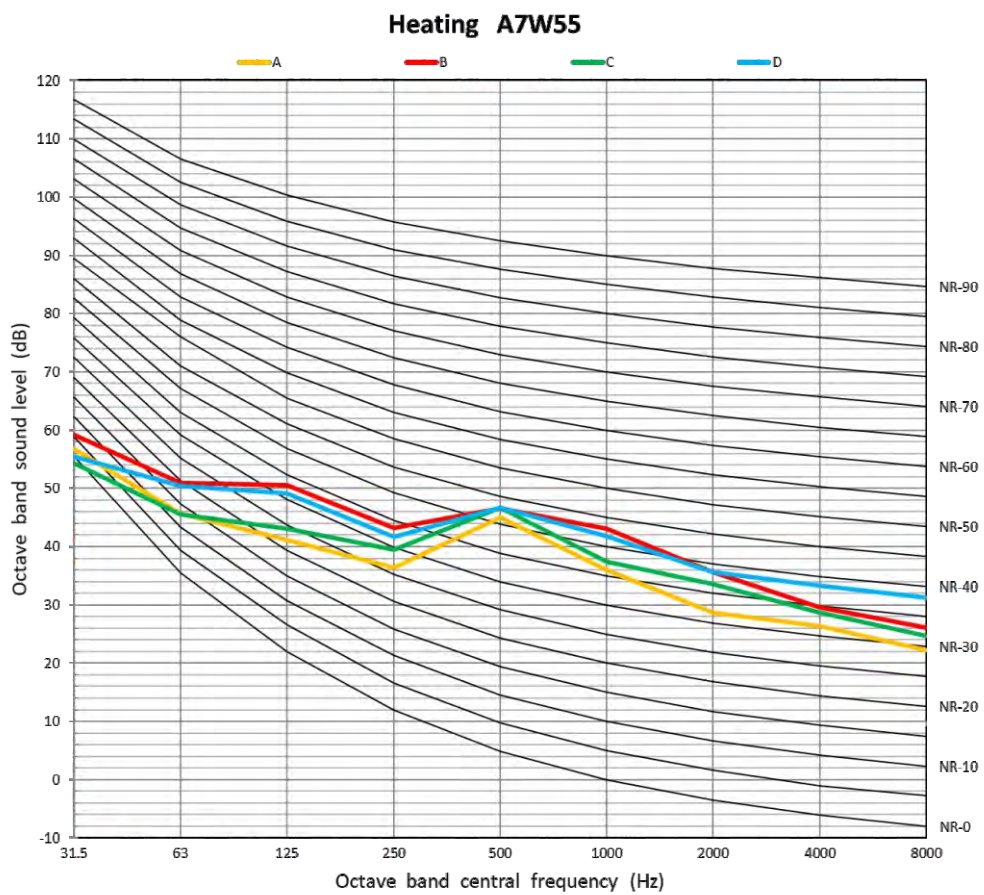
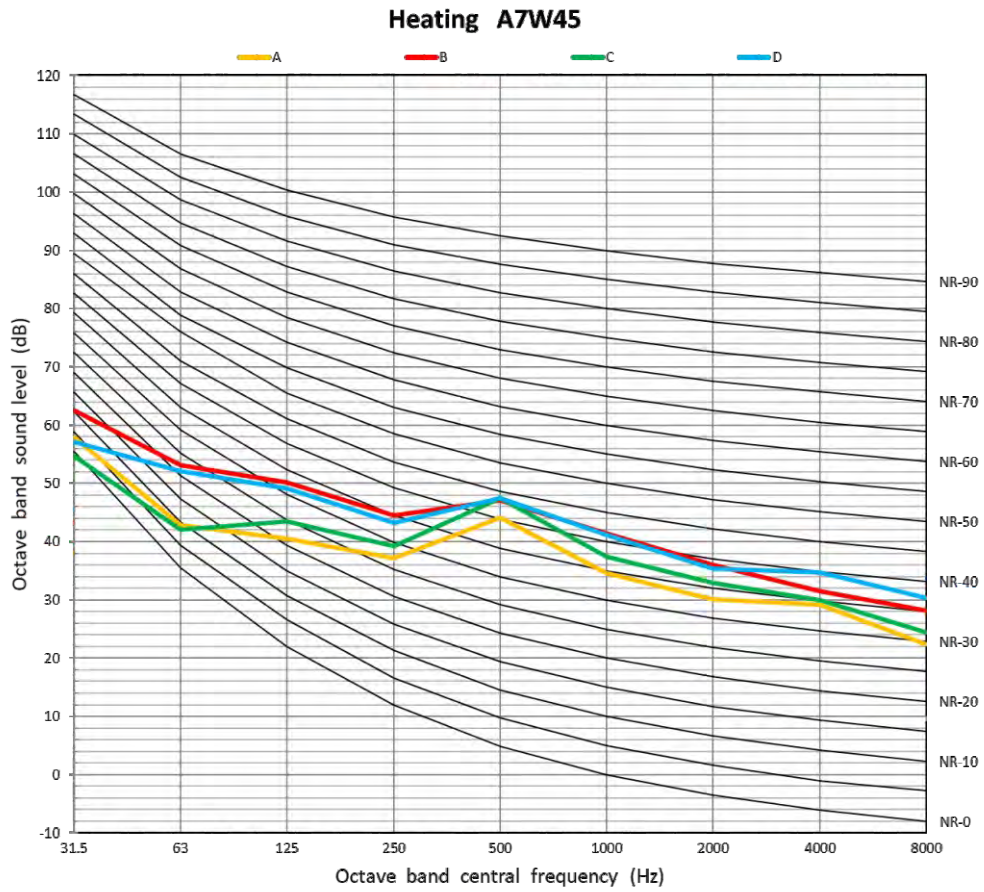

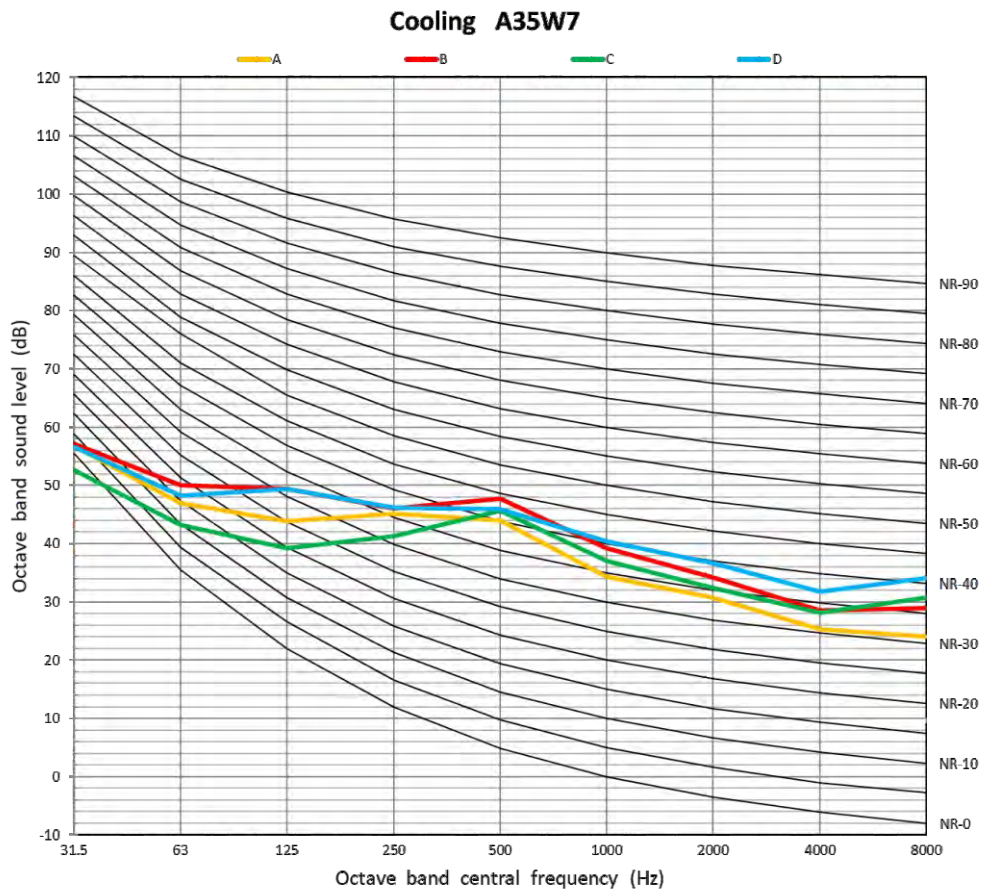
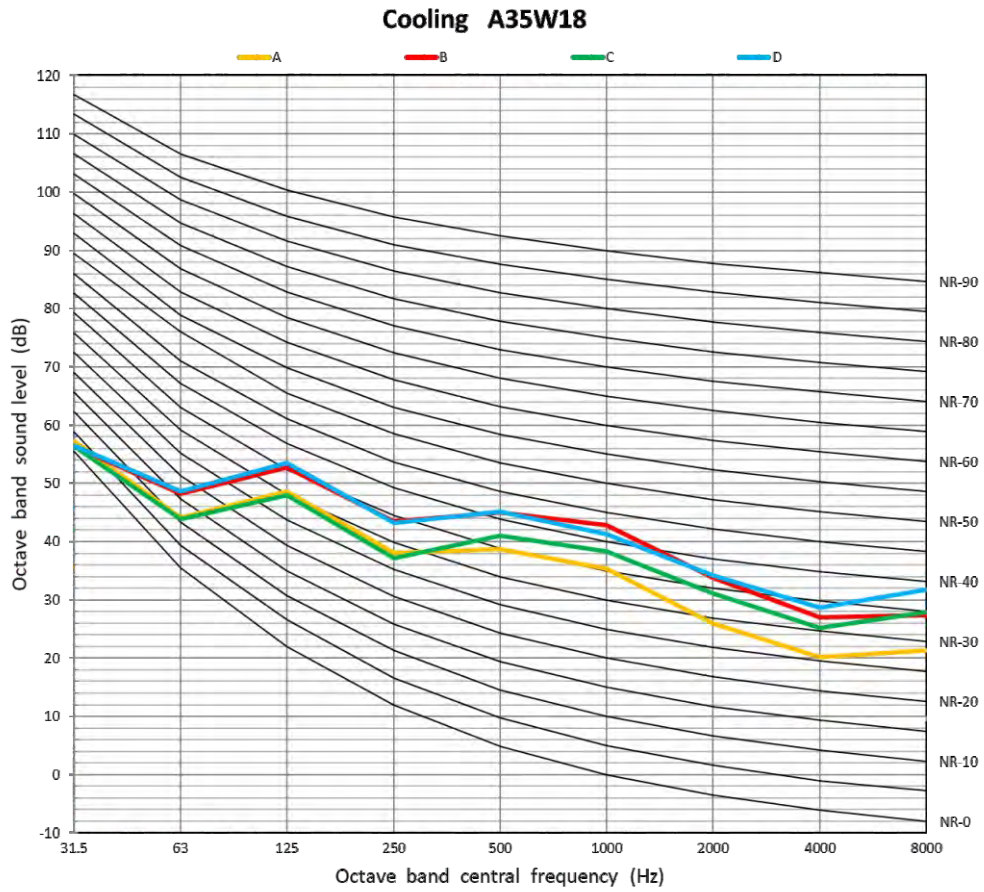

7.2.2 Octave band levels for 10 kW unit

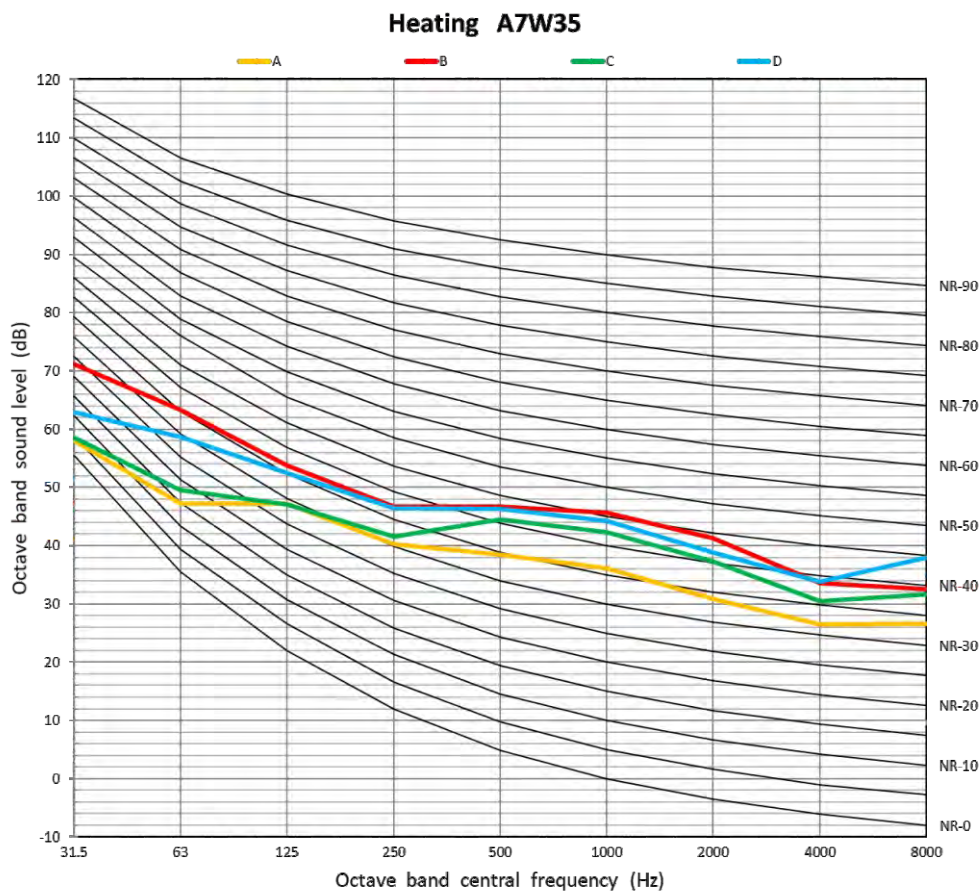
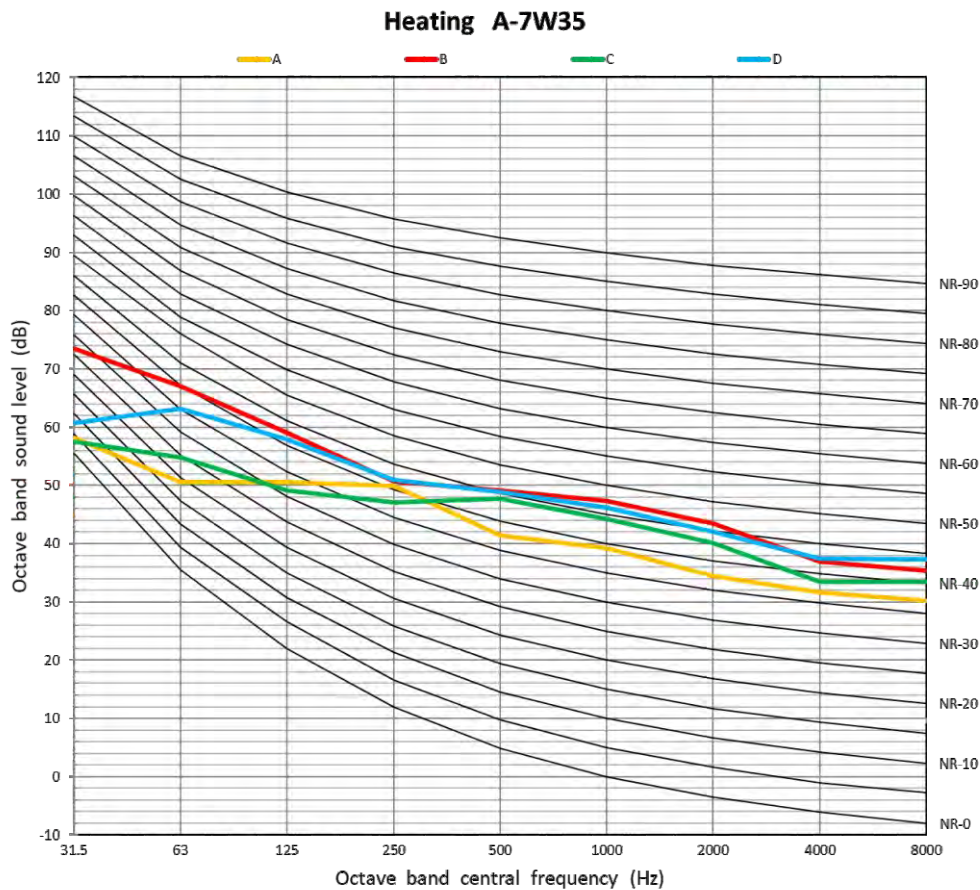

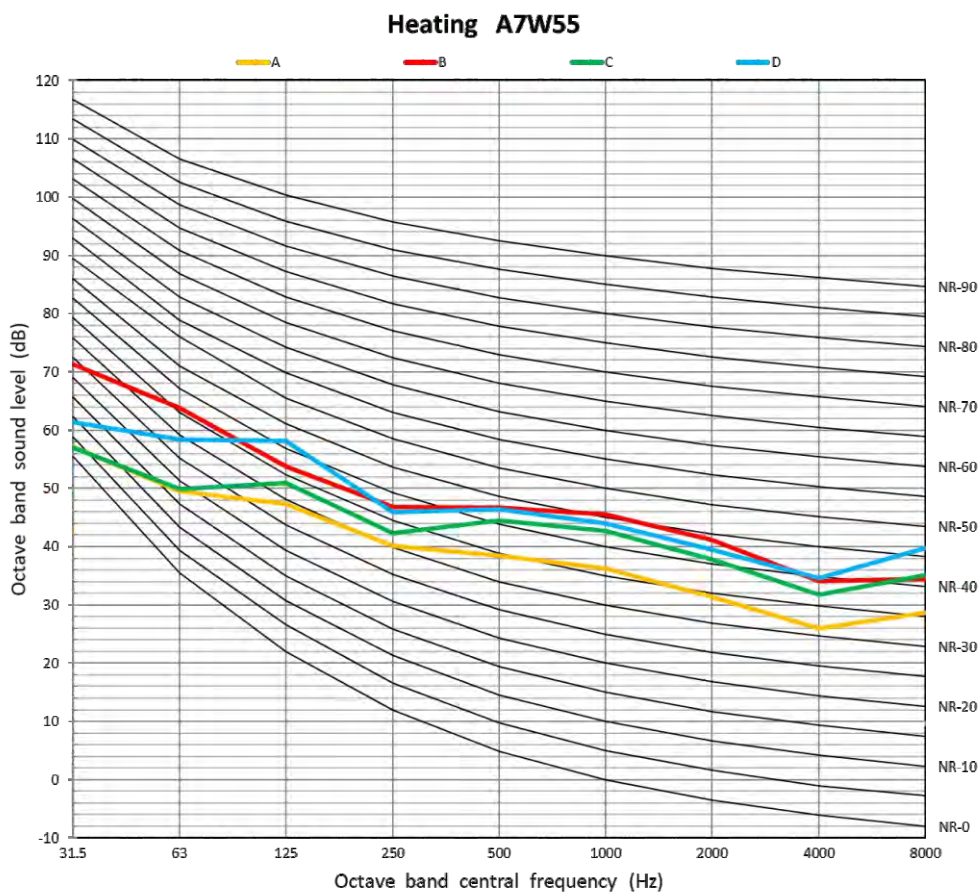
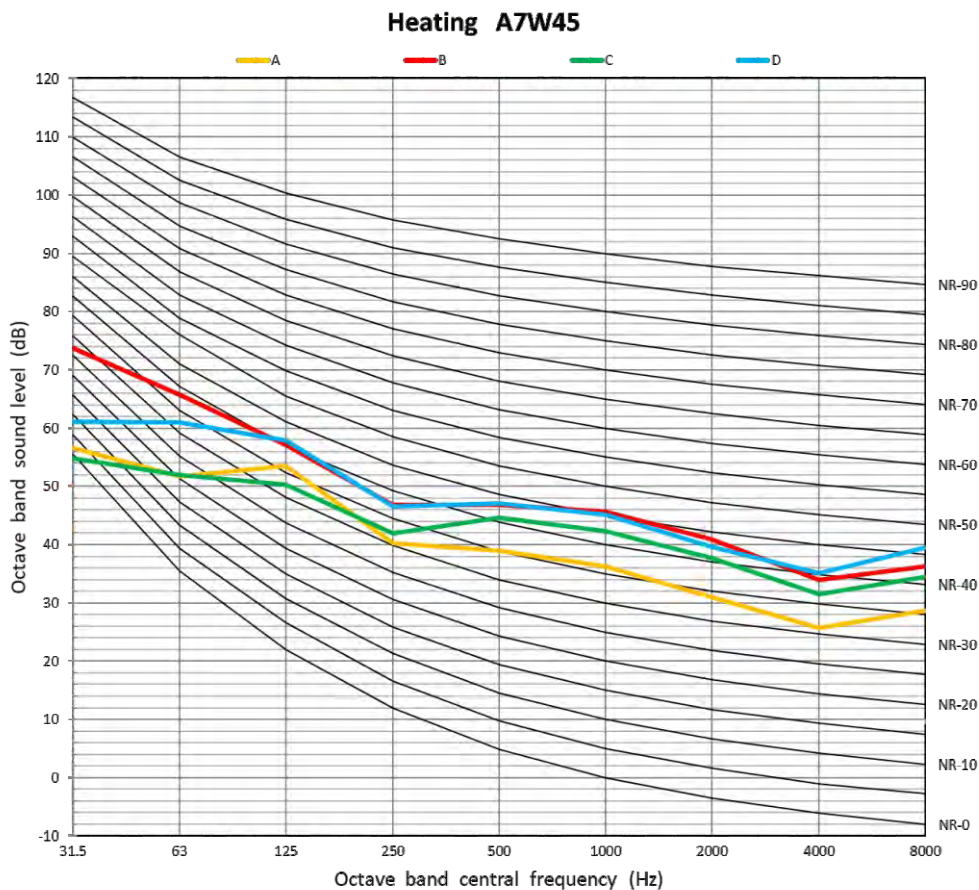

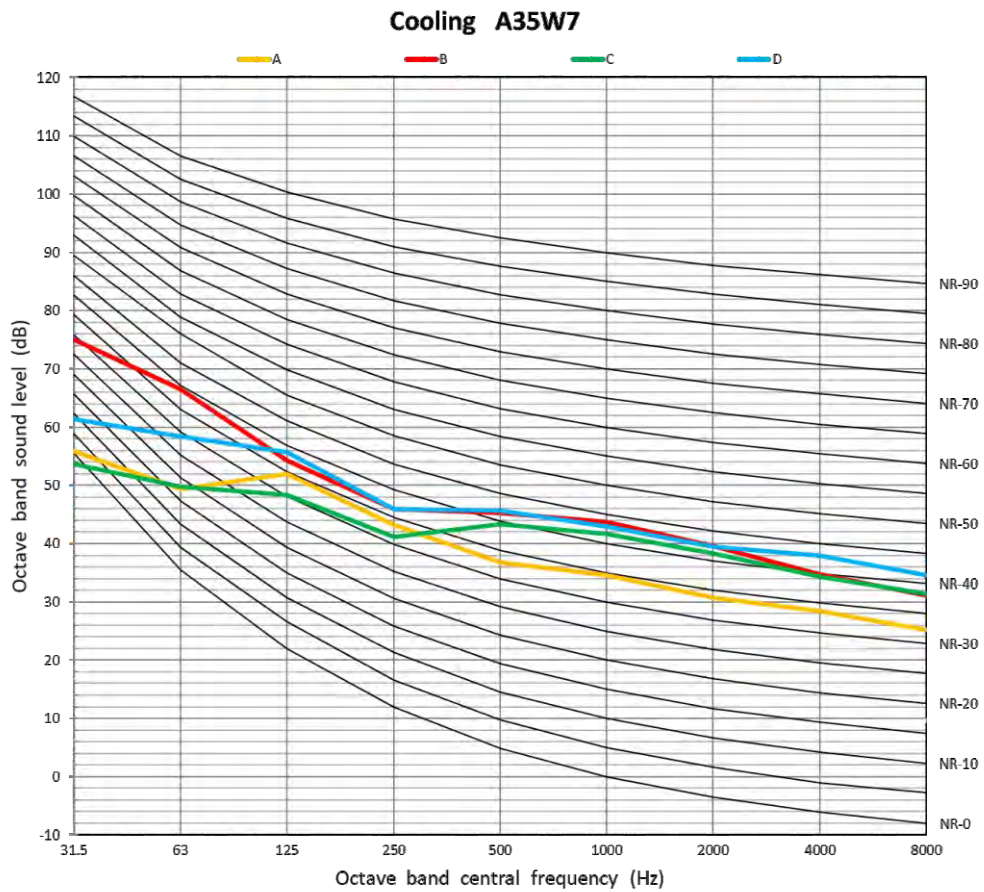
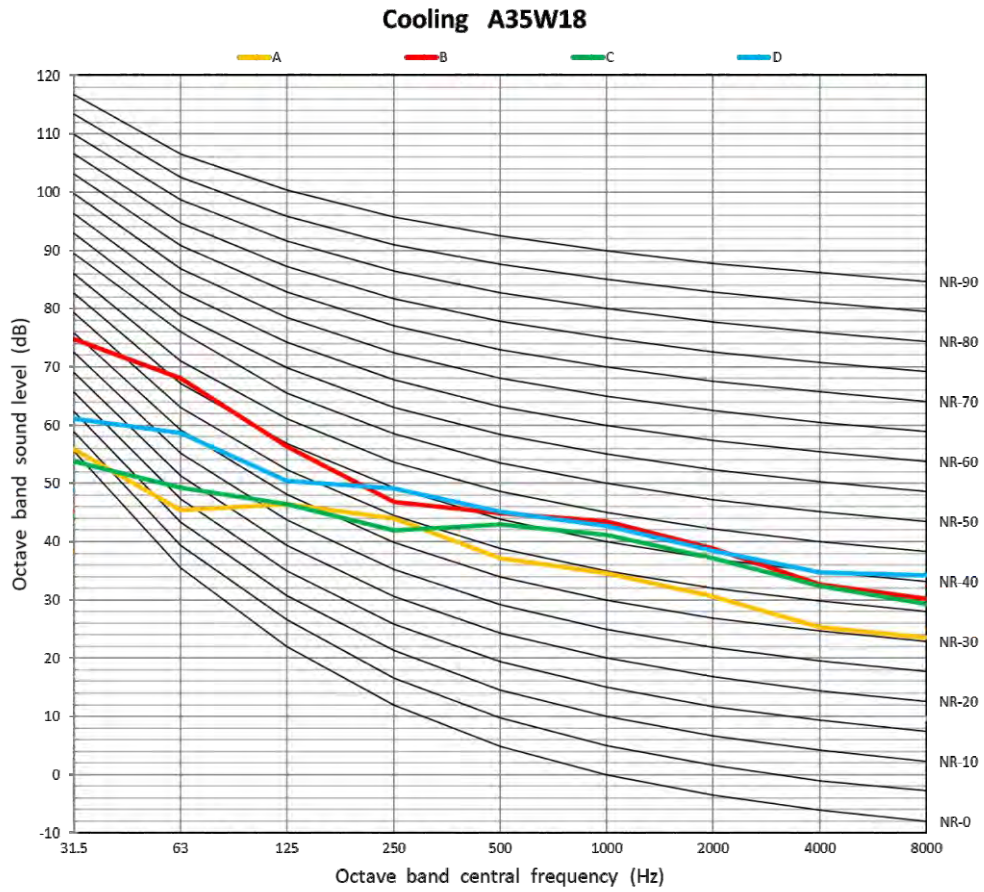

7.2.3 Octave band levels for 16 kW unit

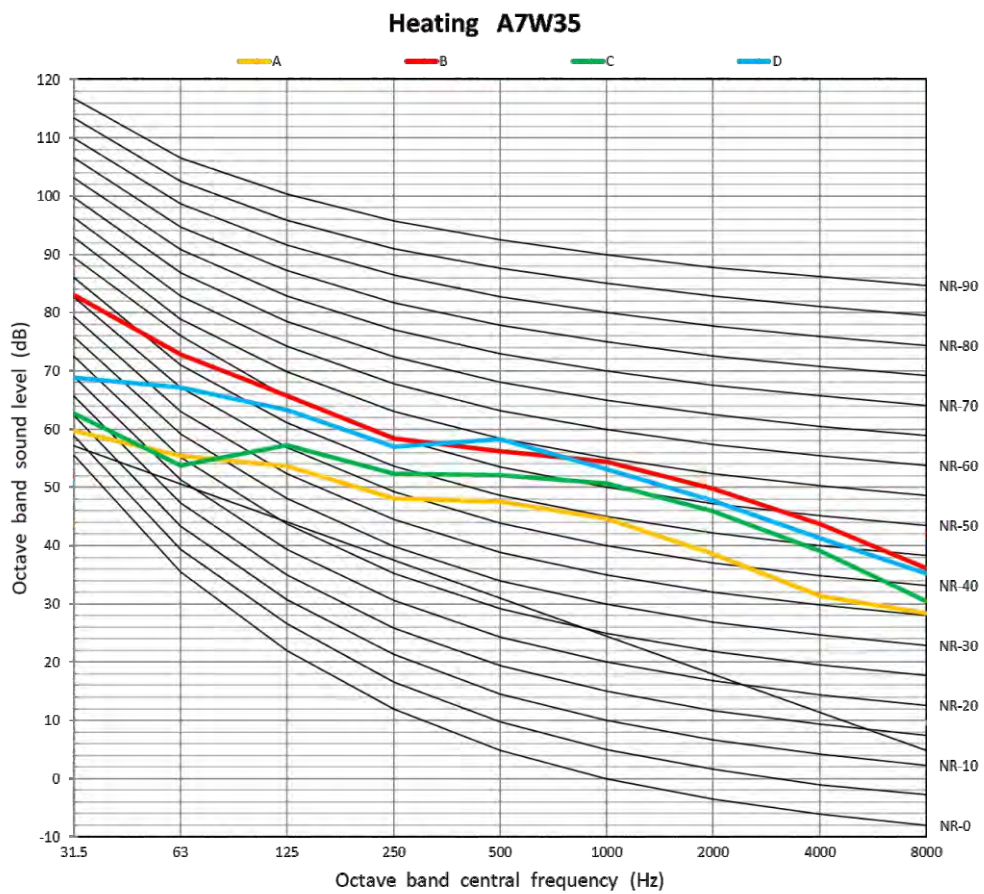
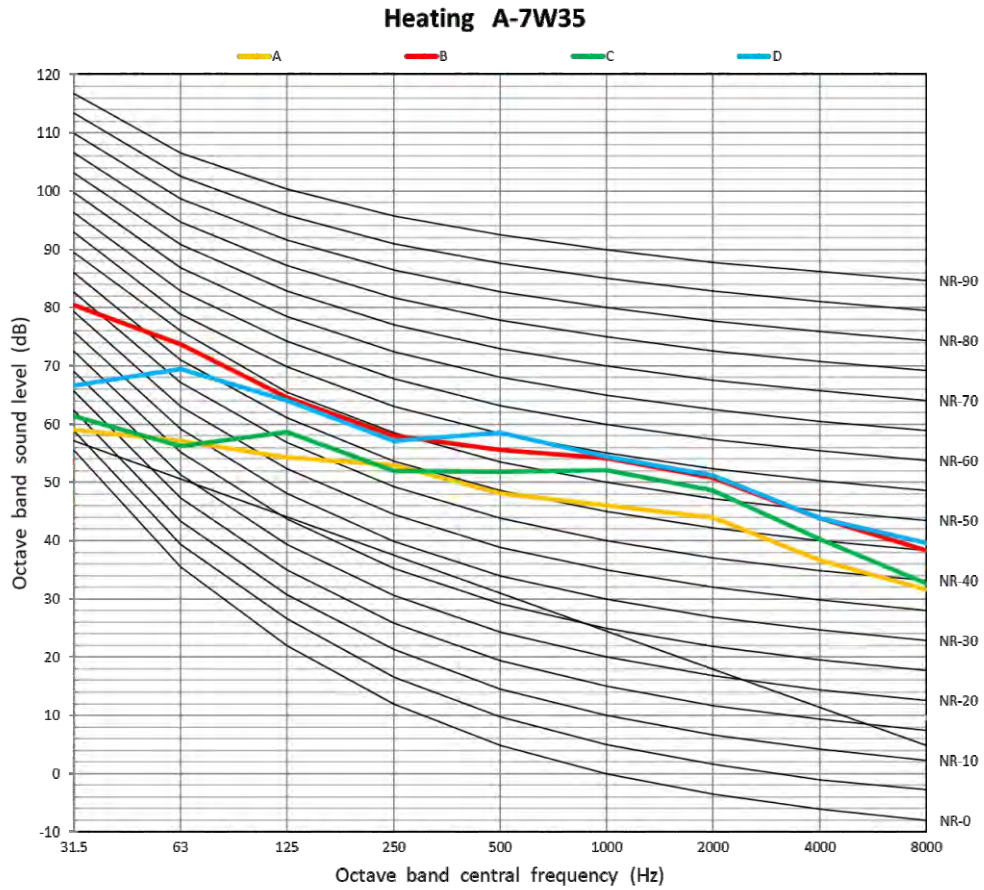

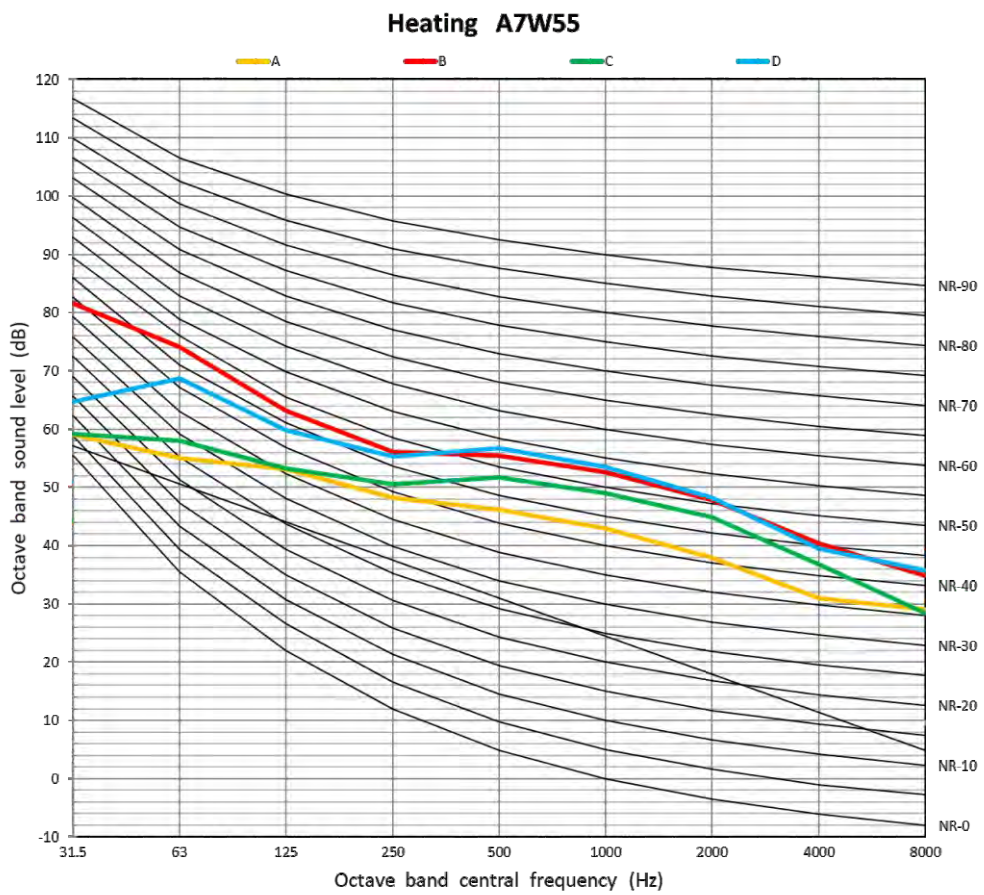
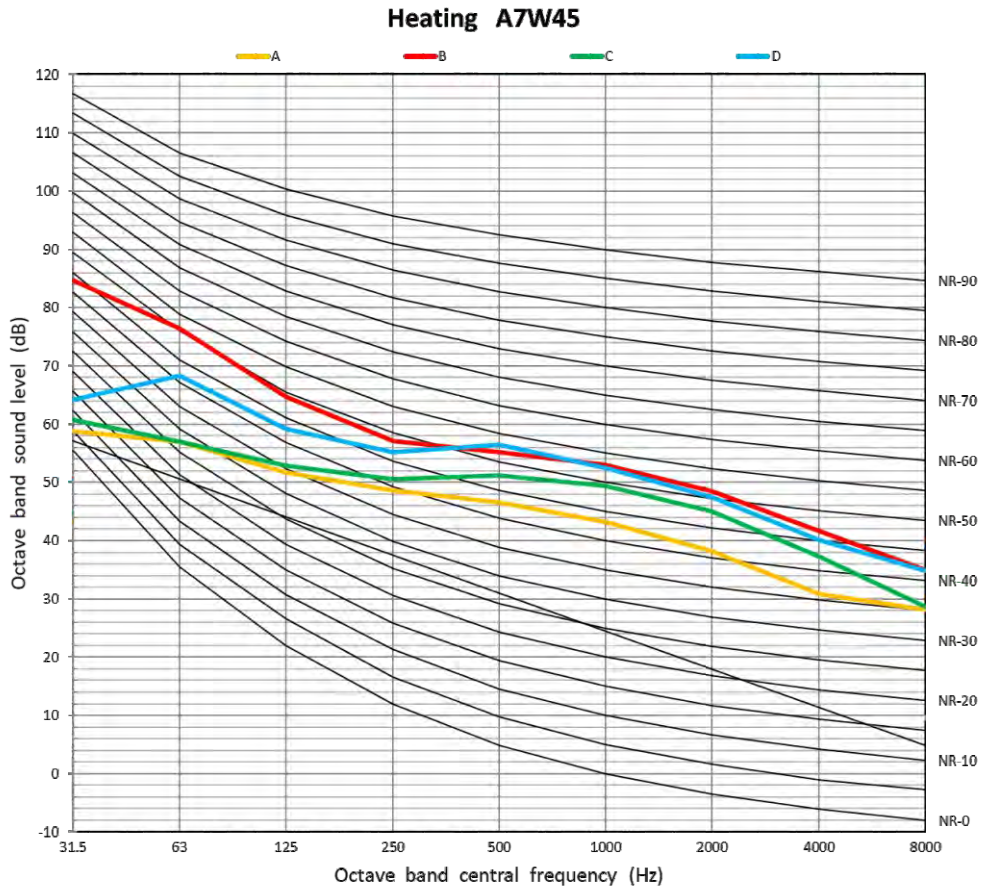

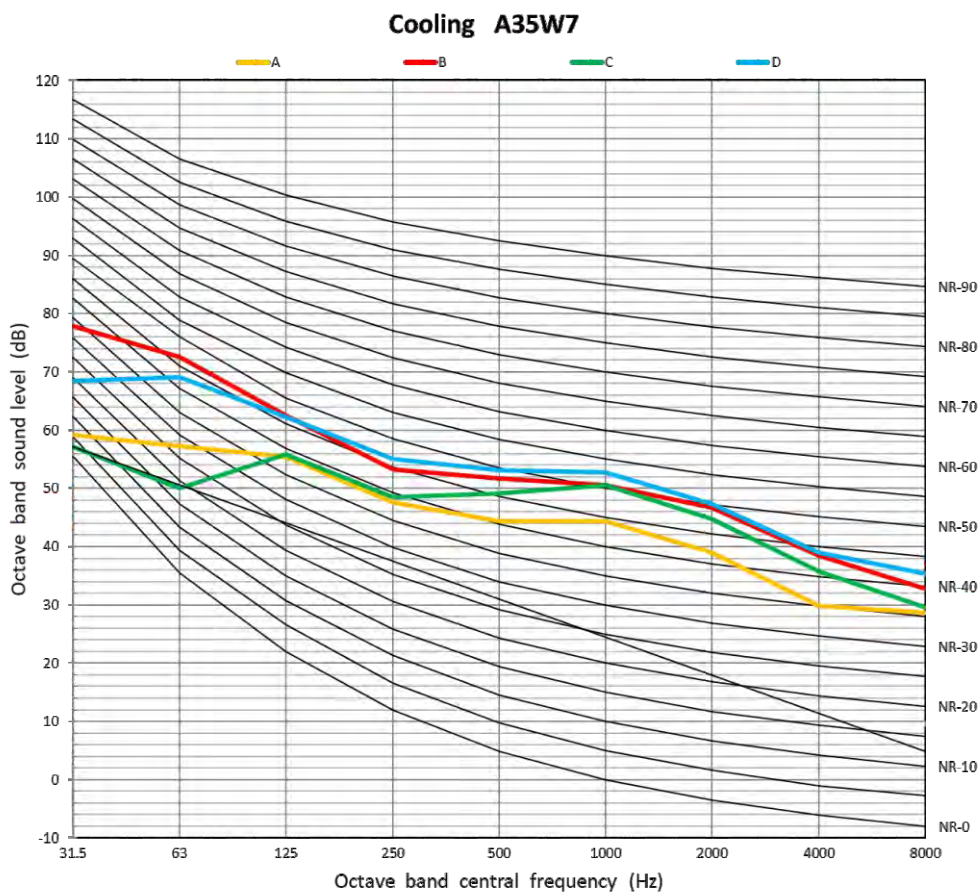
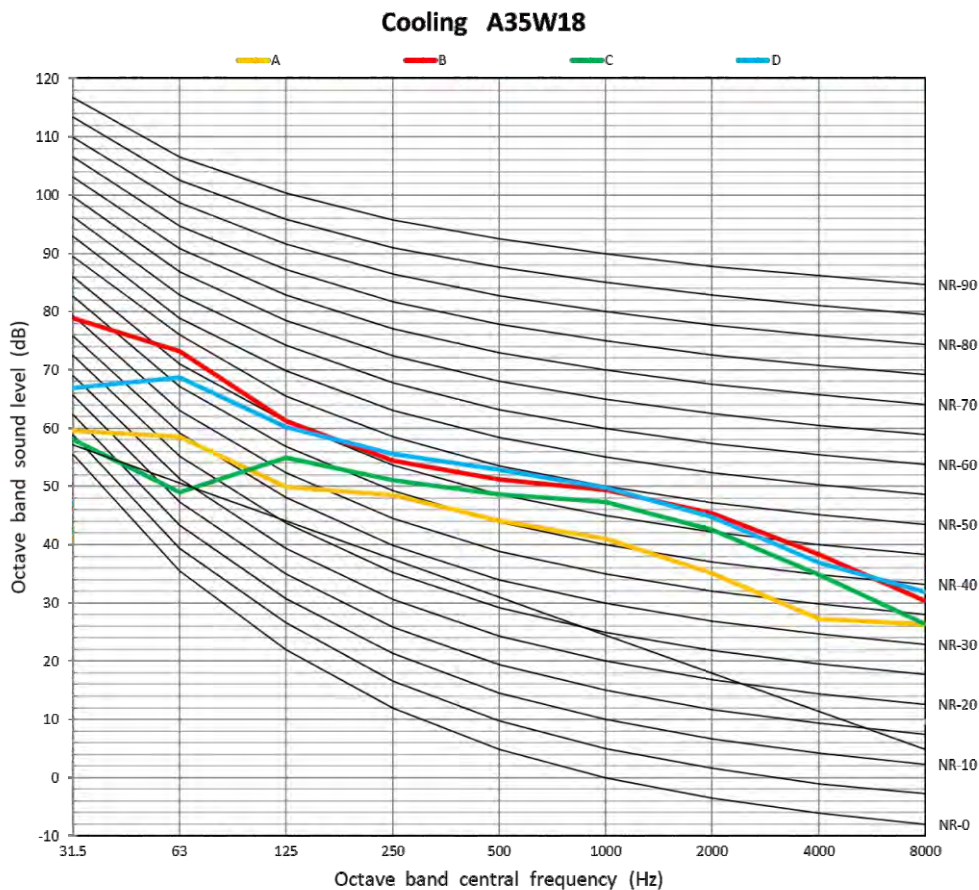

Centrometal

HEATING TECHNIQUE

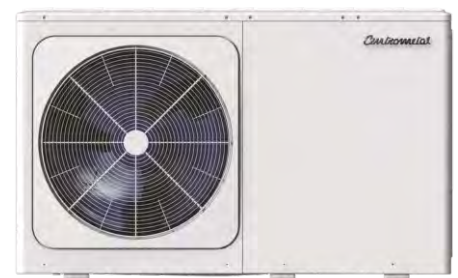

Company assumes no responsibility for possible inaccuracies in this book originated typographical errors or rewriting, all figures and diagrams are principal and it is necessary to adjust each actual situation on the field, in any case the company reserves the right to enter their own products such modifications as considered necessary.

Centrometal d.o.o. Glavna 12, 40306 Macinec, Croatia

central tel: +385 40 372 600, fax: +385 40 372 611
service tel: +385 40 372 622, fax: +385 40 372 621

www.centrometal.hr
e-mail: servis@centrometal.hr